



SUPER STEEL
I N S T R U M E N T S

CATALOGUE

SURGICAL INSTRUMENTS

Quality Is Our Main Concern





Buck
SST-1-101-18
Percussion Hammer
18.5 cm



Buck
SST-1-102-18
20cm



Dejerine
SST-1-103-20
Percussion Hammer
20cm



Dejerine
SST-1-104-21
Percussion Hammer
21cm



Taylor Mod. USA
SST-1-105-20
Percussion Hammer
20cm



Wartenberg
SST-1-106-19
Pinwheel
18 cm



Pinard
SST-1-107-18
Stethoscope
18 cm



Pinard
SST-1-108-15
Stethoscope
15cm



Magill
SST-2-101-15
Catheter Introducing Forceps
14.5 cm , 20cm, 25 cm



Miller
SST-1-101-18
Laryngoscope Sets



Miller-Baby
SST-2-103-00
Laryngoscope Sets



Miller
SST-2-104-00
Laryngoscope Blade
Fig. 0, Fig. 1, Fig. 2, Fig. 3, Fig. 4



Guedel-Negus
SST-2-105-00
Laryngoscope Sets
Fig. 2, Fig. 3, Fig. 4



Guedel-Negus
SST-2-106-00
Laryngoscope Sets
Fig. 1, Fig. 2, Fig. 3, Fig. 4



Guedel-Negus
SST-2-107-01
Laryngoscope Blades
Fig. 1, Fig. 2, Fig. 3, Fig. 4



McIntosh
SST-2-108-00
McIntosh



McIntosh
SST-2-109-0
Laryngoscope Blades
Fig. 0, Fig. 1, Fig. 2, Fig. 3, Fig. 4



McIntosh
SST-2-110-00
Laryngoscope Sets
Fig. 1, Fig. 2, Fig. 3, Fig. 4



Foregger
SST-2-111-01
Laryngoscope Blades
Fig. 1, Fig. 2, Fig. 3, Fig. 4



Battery Handle
SST-2-112-00
Battery Handle



McIntosh
SST-2-114-00

Laryngoscope Sets fiber optic
Fig. 1, Fig. 2, Fig. 3



McIntosh
SST-2-115-00

Laryngoscope Sets fiber optic
Fig. 1, Fig. 2, Fig. 3



McIntosh
SST-2-116-00

Laryngoscope Sets fiber optic
Fig. 1, Fig. 2, Fig. 3



McIntosh
SST-2-113-00

Laryngoscope Sets
Fig. 1, Fig. 2, Fig. 3, Fig. 4

Trocars



Universal
SST-3-101-04
Trocar
14 cm



Nelson
SST-3-102-07
Trocar
20cm



Lichtwitz
SST-3-103-19
Antrum Trocar
18.5 cm



Adson
SST-3-104-21
Suction Cannula
20cm



Frazier
SST-3-105-10
Suction Cannula
24 cm



Frazier
SST-3-106-06
Suction Cannula
19.5 cm

Trocars



Poppen
SST-3-107-06
Suction Cannula
18 cm



Luer
SST-3-108-30
Suction Tube working length 110 mm



Yasargil
SST-3-109-15
Suction Tube working length 150 mm with Luer
hub



Yankauer
SST-3-110-27
Suction Tube complete with suction tip and
connector
31 cm



Yankauer
SST-3-111-00
Suction Tube
31 cm , 15 cm, 2.5 cm, 10 cm



Poole
SST-3-112-22
Suction Tube
22cm



Poole
SST-3-113-22
Suction Tube
22.5 cm



Nuboer
SST-3-114-21
Suction Tube
21cm



Nuboer
SST-3-115-21
Suction Tube
21cm



Quinke
SST-3-116-10
Lumbar Puncture Needle



Tuohy
SST-3-117-12
Lumbar Puncture Needle Luer Lock connection
with special tip



Verres
SST-3-118-20
Insufflation Cannula Luer Lock connection
15 cm



Verres

SST-3-119-20

Insufflation Cannula Luer Lock connection

17 cm



Kalt
SST-4-105-14
Needle Holder
13.5 cm



Barraquer-Troutman
SST-4-106-10
Micro Needle Holder
10 cm , 10.5 cm



Arruga
SST-4-107-14
Micro Needle Holder
13.5 cm



Barraquer-Troutman
SST-4-108-10
Micro Needle Holder
10.5 cm , 11.5cm



Barraquer
SST-4-109-11
Micro Needle Holder
11.5cm, 13.5 cm , 14 cm



Barraquer
SST-4-110-13
Micro Needle Holder
13.5 cm



Castroviejo-Fino
SST-4-111-01
Micro Needle Holder
13cm



Castroviejo-Fino
SST-4-112-01
Micro Needle Holder
13cm



Castroviejo-Fino
SST-4-113-01
very delicate jaw with lock
13cm



Castroviejo
SST-4-114-14
Micro Needle Holder with lock
Fig.65, Fig.69, Fig.88 L, 14 cm



Castroviejo
SST-4-115-14
Micro Needle Holder
14 cm



Castroviejo
SST-4-121-14
Micro Needle Holder with lock
14 cm



Castroviejo
SST-4-122-14
Micro Needle Holder
14 cm



Castroviejo
SST-4-124-13
Micro Needle Holder with lock



Arruga
SST-4-123-16
Needle Holder delicate
16 cm



Castroviejo
SST-4-125-12
Micro Needle Holder with lock
12 cm



Derf
SST-4-126-12
Needle Holder
12 cm, 13cm

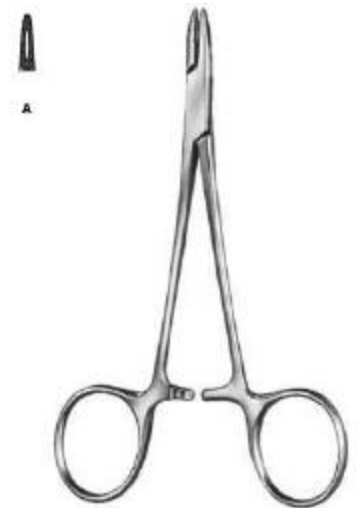

Collier
SST-4-127-12
Needle Holder
12.5 cm



WeSSTer
SST-4-128-13
Needle Holder
13cm

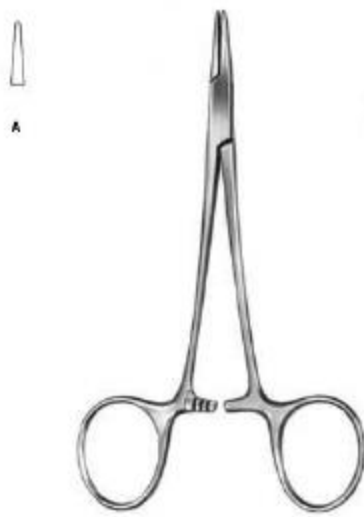

Halsey
SST-4-129-13
Needle Holder
13.5 cm



Neivert
SST-4-130-13
Needle Holder
12.5 cm



Metzenbaum
SST-4-141-18

Needle Holder one grooved and fenestrated jaw
18.5 cm



M. G. Hospital
SST-4-142-17
Needle Holder
17.5 cm



Mayo-Hegar
SST-4-143-14
Needle Holder
14.5 cm , 16 cm , 18.5 cm , 24 cm



Adson

SST-4-140-18

Needle Holder one fenestrated jaw
18 cm



Metzenbaum

SST-4-141-18

Needle Holder one grooved and fenestrated jaw
18.5 cm



M. G. Hospital

SST-4-142-17

Needle Holder
17.5 cm



Mayo-Hegar

SST-4-143-14

Needle Holder

14.5 cm , 16 cm , 18.5 cm , 20.5 cm , 24 cm ,
26.5 cm

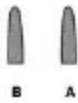

Brown

SST-4-145-13

Needle Holder

13cm, 18 cm



Mayo Hegar

SST-4-144-16

Needle Holder

16 cm , 18.5 cm , 20.5 cm

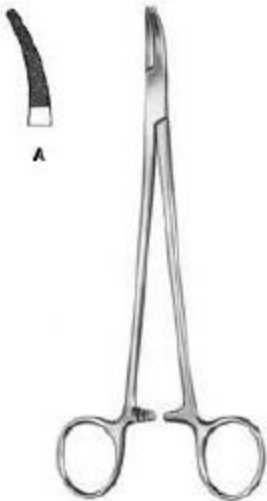

Heaney
SST-4-146-21
Needle Holder
20.5 cm



Jamison
SST-4-147-23
Needle Holder
23.5 cm



Masson
SST-4-148-27
Needle Holder
26.5 cm



Finochietto
SST-4-149-27
Needle Holder
26.5 cm



Wangenstein
SST-4-150-27
Needle Holder
26.5 cm

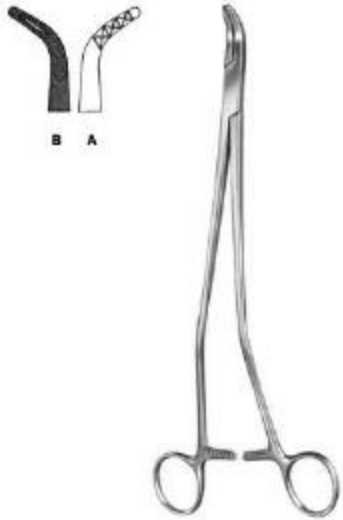

Johnson
SST-4-151-27
Needle Holder
27 cm

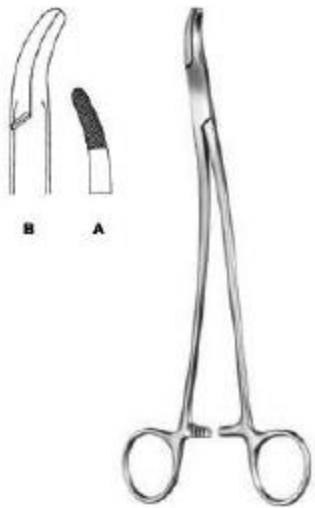

Stratte
SST-4-152-23
Needle Holder
23 cm



Olsen-Hegar
SST-4-153-14
Needle Holder
14 cm

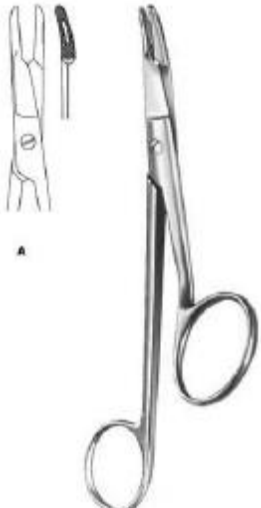

Gillies
SST-4-154-16
Needle Holder
16 cm



Crile
SST--155-15
Needle Holder
15 cm



Mathieu
SST-4-156-14
Needle Holder
14 cm, 17 cm , 20cm



Mathieu
SST-4-157-14
Needle Holder
16.5 cm



Toennis
SST-4-158-18
Needle Holder
18.5 cm



Lichtenberg
SST-4-159-20
Needle Holder
20cm



Micro Needle Holder
SST-4-160-16
Micro Needle Holder
16 cm



Micro Needle Holder
SST-4-161
Micro Needle Holder
19 cm



Hepp-Scheidel
SST-4-162-18
Micro Needle Holder smooth jaw
18 cm

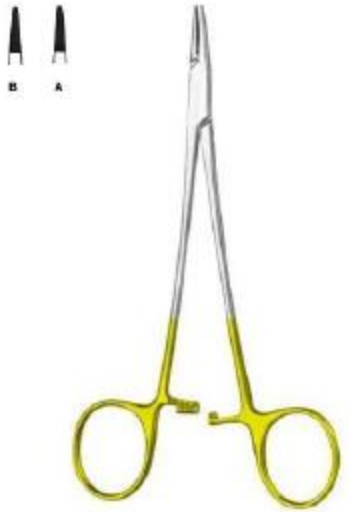

WeSSTter
SST-4-163-13
Needle Holder with automatic release ratchet
also for lefthanders
Fig.233, 16 cm , 12 cm, 13cm, 15 cm



Micro Needle Holder
SST-4-164-15
Micro Needle Holder
15 cm, 18 cm, 21cm, 23 cm



JABOMA
SST-4-165-18
Micro Needle Holder
18 cm



Castroviejo
SST-4-166
Micro Needle Holder
Fig.233, 16 cm , 12 cm, Fig.18 L, 14.5 cm , 18 cm, 21cm



Arruga
SST-4-167
Needle Holder
Fig.233, 16 cm , 12 cm, Fig.18 L, 16 cm



Castroviejo
SST-4-168-13
Micro Needle Holder
12.5 cm



Barraquer
SST-4-169-13
13 cm



Barraquer
SST-4-170-13
Micro Needle Holder
13 cm



WeSSTer
SST-4-171-13
Needle Holder
13 cm



Derf
SST-4-173-12
Needle Holder
12 cm



Kilner
SST-4-172-13
13 cm



Hegar-Baumgartner
SST-4-174-13
Needle Holder
13 cm , 14.5 cm



Halsey
SST-4-175-12
Needle Holder
13 cm , 12 cm



Crile-Wood
SST-4-176-15
Needle Holder
15 cm



Sarot
SST-4-177-18
Needle Holder
18 cm, 20 cm, 26 cm



Mayo-Hegar
SST-4-178-16
Needle Holder standard profile
16 cm, 18 cm, 20 cm, 24 cm, 26 cm, 30 cm



Heaney
SST-4-179-20
Needle Holder
20 cm, 24 cm, 26 cm



DeBakey
SST-4-180-18
Needle Holder delicate pattern mini profile
18 cm, 20 cm, 23 cm, 26 cm, 31 cm



Masson
SST-4-181-27
Needle Holder
26.5 cm



Ryder (Martin)
SST-4-182-13

Needle Holder
12.5 cm, 15 cm, 18 cm, 20 cm, 23 cm, 26 cm



Martin
SST-4-183-15

Needle Holder mini profile elastic type
15 cm, 17 cm, 20 cm



Wangensteen
SST-4-184-27

Needle Holder standard profile
27 cm



Hegar-Vascular
SST-4-185-14

Needle Holder micro profile
14 cm, 18.5 cm, 20.5 cm, 23 cm



Bozemann
SST-4-186-20

Needle Holder standard profile
20.5 cm, 24 cm, 26.5 cm, 29 cm



Hegar
SST-4-187-20
Needle Holder standard profile
20 cm, 23.5 cm

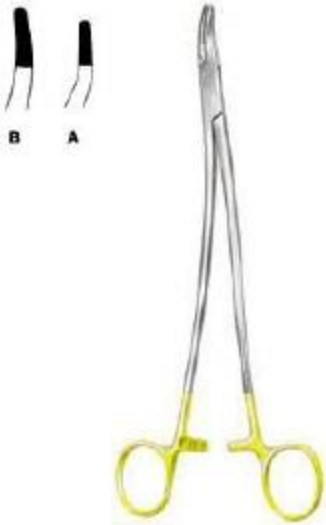

Stratte

SST-4-188-22

Needle Holder standard profile
23 cm



Microvascular

SST-4-189-00

Needle Holder slender pattern micro profile
14 cm, 17.5 cm, 20 cm, 23 cm



Mathieu

SST-4-190-14

Needle Holder
14 cm, 17 cm, 20 cm



Mathieu

SST-4-191-14

Needle Holder
14 cm, 17 cm, 20 cm



Mathieu

SST-4-192-17

Needle Holder standard profile with interior
ratchet
17 cm, 20 cm, 23 cm



Toennis

SST-4-193-18

Needle Holder
18.5 cm



Lichtenberg
SST-4-194-20

Needle Holder lightweight model standard profile
20 cm



Langenbeck
SST-4-195-18

Needle Holder
18 cm, 20.5 cm, 23 cm



Zweifel
SST-4-196-20

Needle Holder with hinged ratchet standard
profile
20.5 cm, 23 cm



Reverdin
SST-4-197-15

Reverdin Needle short

14 cm Fig. 1, 14 cm Fig. 2, 14 cm Fig. 3, 14 cm Fig. 4



Reverdin
SST-4-198-19

Reverdin Needle medium

19.5 cm Fig. 1, 19.5 cm Fig. 2, 19.5 cm Fig. 3, 19.5 cm Fig. 4



Reverdin
SST-4-199-23

Reverdin Needle long

23 cm Fig. 1, 23 cm Fig. 2, 23 cm Fig. 3, 23 cm Fig. 4



Schmieden-Dick
SST-4-201-01
Ligature Needle malleable
29 cm

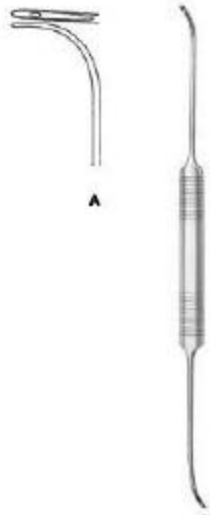

Schmieden
SST-4-202-21
Ligature Needle
24 cm



Ligature Needle Malleable
SST-4-203-20
Ligature Needle malleable
20.5 cm

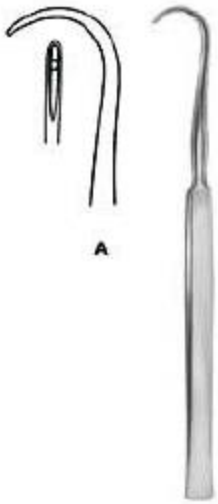

Cooper
SST-4-204-19
Ligature Needle
18.5 cm



Kronecker
SST-4-205-13
Ligature Needle delicate for right hand
12.5 cm

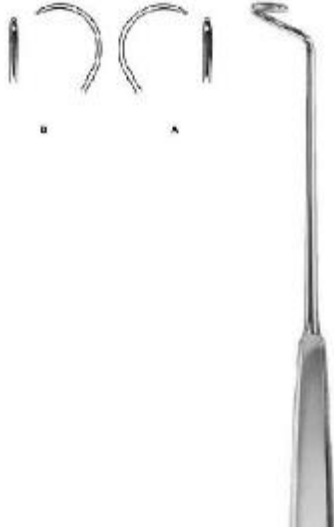

Deschamps
SST-4-206-24
24 cm



Deschamps
SST-4-207-20

Ligature Needle blunt for right hand
20 cm



Deschamps
SST-4-208-20

Ligature Needle sharp for right hand
20 cm



Deschamps
SST-4-209-21

Ligature Needle blunt for right hand
20 cm



Deschamps
SST-4-210-21

Ligature Needle sharp for right hand
20 cm

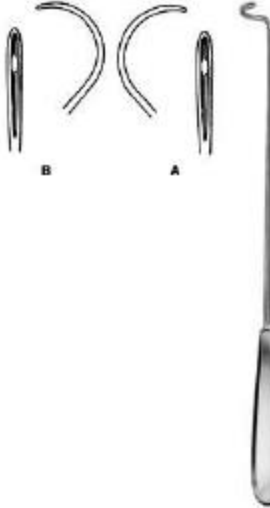

Deschamps
SST-4-211-27

Ligature Needle blunt for right hand
27 cm

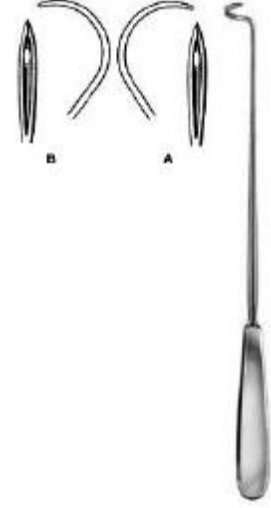

Deschamps
SST-4-212-27

Ligature Needle sharp for right hand
27 cm

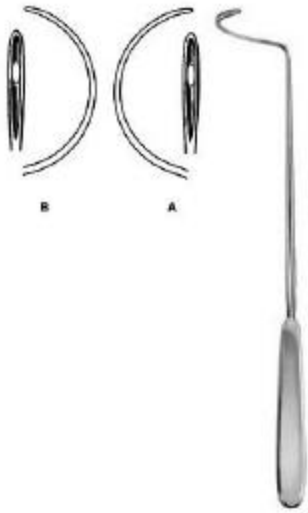

Deschamps
SST-4-213-28

28 cm



Deschamps
SST-4-214-20

Ligature Needle sharp for right hand
20 cm



Deschamps
SST-4-215-20

Ligature Needle blunt for right hand
20 cm



Deschamps
SST-4-216-20

Ligature Needle blunt for right hand
21 cm

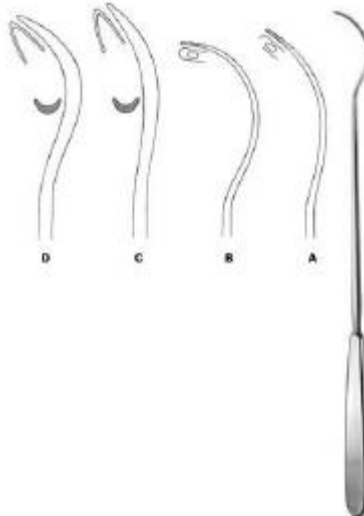

Brunner
SST-4-217-30

Ligature Needle
21 cm



Kirschner
SST-4-218-25

Ligature Conductor
25.5 cm



Ligature Conductor
SST-4-219-28
Ligature Conductor
28 cm



Modell Wien
SST-4-220-23
Ligature Catcher
23.5 cm



Michel
SST-4-221-12
Clip Applying Forceps
12 cm



Hegenbarth
SST-4-222-12
Clip Applying Forceps
12 cm

Scalpels



Dissecting Knife
SST-5-101-01

Dissecting Knife with metal handle
15 cm, 15.5 cm, 16 cm , 17 cm



Autopsy Knife
SST-5-102-10

Autopsy Knife
25.5 cm



Walb
SST-5-104-17
Post Mortem Knife



Virchow
SST-5-105-20

Virchow
28.5 cm, 33.5 cm, 38 cm



Scalpel Handle
SST-5-108-04

Scalpel Handle
13.5 cm



Scalpel Handle
SST-5-109-34

Scalpel Handle
16 cm

Scalpels



Scalpel Handle
SST-5-110-41
Scalpel Handle
21cm



Scalpel Handle
SST-5-111-45
Scalpel Handle
21cm



Collin
SST-5-112-08
Scalpel Handle with hollow handle
13.5 cm



Collin
SST-5-113-09
Scalpel Handle with hollow handle
14.5 cm



Scalpel Handle
SST-5-114-03
Scalpel Handle
12 cm



Scalpel Handle
SST-5-115-04
Scalpel Handle
12 cm

Scalpels



Scalpel Handle
SST-5-116-05
Scalpel Handle
12 cm



Scalpel Handle
SST-5-117-31
Scalpel Handle
21.5 cm



Scalpel Handle
SST-5-118-35
Scalpel Handle
21cm



Scalpel Handle
SST-5-119-07
Scalpel Handle
16 cm



Scalpel Handle
SST-5-120-71
Scalpel Handle
12.5 cm



Scalpel Handle
SST-5-121-03
Scalpel Handle
15.5 cm

Scalpels



Amputation Knife
SST-5-127-16
Amputation Knife
29 cm



Amputation Knife
SST-5-128-19
Amputation Knife
32.5 cm



Catlin
SST-5-129-16
Interosseous Knife with hollow handle
29 cm



Resection Knife
SST-5-130-06
Resection Knife
18 cm



Langenbeck
SST-5-131-05
Resection Knife
18 cm



Langenbeck
SST-5-132-05
Langenbeck
18 cm

Scalples



Razor Knife
SST-5-133-00

Razor Knife hollow blades on both sides cutting length 75mm



Schink

SST-5-134-00

Dermatome complete with 2 skin fixing plates and one blade

31 cm



Schink

SST-5-135-01

Spare Blade spare blade for KE-05-134-00

&nb



Schink

SST-5-136-02

Skin Fixing Plate for KE-05-134-00

Scissors



Standard BL / BL Straight
SST-5-201-13

Operating Scissor Special Price:
\$1.25



Standard SH / BL STR
SST-5-202-13

Operating Scissors

12 cm, 13cm, 14.5 cm , 16.5 cm, 18.5 cm , 20.5 cm



Standard SH / SH STR
SST-5-204-13

Operating Scissors

12 cm, 13cm, 14.5 cm , 16.5 cm



Standard BL / BL Curved
SST-5-205-13

Operating Scissors

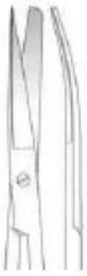

Standard SH / BL Curved
SST-5-206-13

Operating Scissors

12 cm, 13cm, 14.5 cm , 16.5 cm, 18.5 cm , 20.5 cm



Standard SH / SH Curved
SST-5-207-13

Operating Scissors

12 cm, 13cm, 14.5 cm , 16.5 cm

12 cm, 13cm, 14.5 cm , 16.5 cm, 18.5 cm , 20.5 cm

Scissors



Standard BL / BL Curved

SST-5-208-14

Operating Scissors delicate

14.5 cm



Incision Scissor

SST-5-209-14

Operating Scissor

14.5 cm



Deaver

SST-5-210-14

Operating Scissors



Mayo

SST-5-211-15

Dissecting Scissors

14.5 cm , 15 cm, 17 cm , 23.5 cm



Mayo

SST-5-212-23

Dissecting Scissors

23 cm , 22.5 cm, 28 cm



Mayo-Harrington

SST-5-213-22

Dissecting Scissors

23 cm , 22.5 cm, 28 cm

Scissors

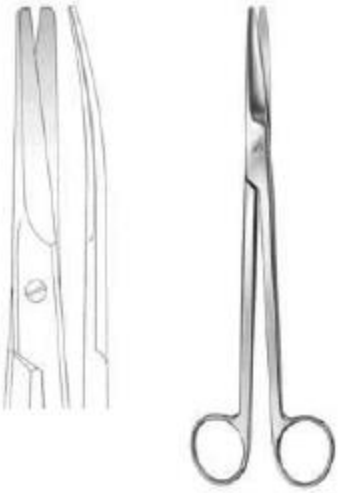

Mayo-Harrington
SST-5-214-22

Dissecting Scissors cur.
22.5 cm, 23 cm , 28 cm

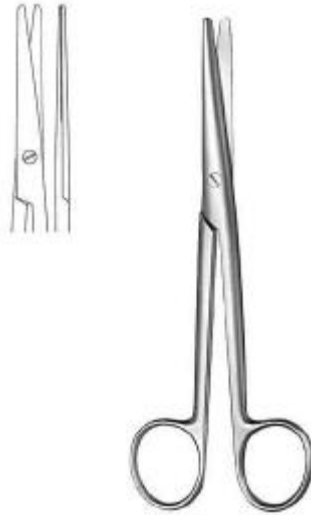

Mayo-Stillie
SST-5-215-17

Dissecting Scissors str.
15 cm, 17 cm

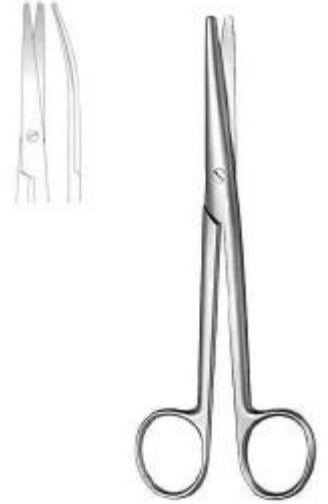

Mayo-Stillie
SST-5-216-15

Dissecting Scissors cur.
15 cm, 17 cm

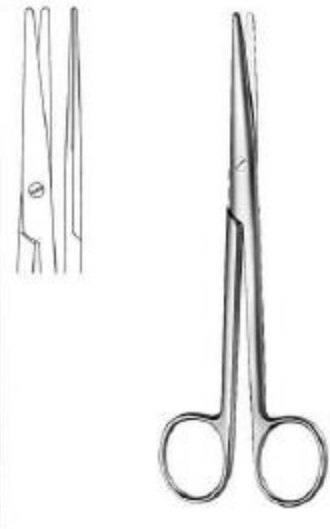

Mayo-Stillie
SST-5-217-19

16 cm, 19.5 cm , 21.5 cm

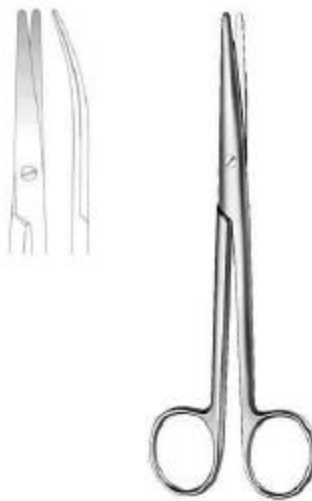

Mayo-Stillie
SST-5-218-16

Dissecting Scissors cur.

16 cm, 19.5 cm , 21.5 cm



Mayo-Noble
SST-5-219-17

Gynecological Scissors

16.5 cm

Scissors



Sims

SST-5-220-23

Gynecological Scissors str.

20cm, 23 cm



Sims

SST-5-221-20

Gynecological Scissors cur.

20cm, 23 cm



Kelly

SST-5-222-16

Operating Scissors

16 cm



Doyen

SST-5-223-17

Gynecological Scissors

18.5 cm



Sims-Siebold

SST-5-224-24

24.5 cm



Sims-Siebold

SST-5-225-24

Gynecological Scissors

24.5 cm

Scissors



Wertheim
SST-5-226-23

Gynecological Scissors

20cm, 23 cm



Metzenbaum
SST-5-227-11

Dissecting Scissors

11



Metzenbaum
SST-5-228-14

Dissecting Scissors

14.5 cm



Metzenbaum
SST-5-229-15

Dissecting Scissors

15.5 cm



Metzenbaum-Nelson
SST-5-230-20

Dissecting Scissors

18 cm, 20.5 cm, 23 cm , 26 cm, 28.5 cm, 31 cm



Metzenbaum-Nelson
SST-5-231-20

Dissecting Scissors

18 cm, 20.5 cm

Scissors



Metzenbaum-Nelson

SST-5-232-20

Dissecting Scissors



Metzenbaum

SST-5-233-14

Dissecting Scissors toothed



Nerve Operating Scissor

SST-5-234-15

Dissecting Scissors

18 cm, 20.5 cm, 23 cm , 26 cm, 28.5 cm, 31 cm

14.5 cm

15.5 cm



Gorney

SST-5-235-19

Face-lift Scissors str.

12.5 cm, 19.5 cm



Gorney

SST-5-236-19

Face-lift Scissors cur.

19.5 cm



Aston

SST-5-237-17

Face-lift Scissors

17 cm

Scissors



Lexer
SST-5-238-16

Dissecting Scissors

16 cm



Cinelli
SST-5-239-14

Nasal Scissors

11.5cm, 14 cm



Thorek
SST-5-240-19

Dissecting Scissors

18.5 cm



Lexer-Baby
SST-5-241-10

Dissecting Scissors

10 cm



Lexer-Fino
SST-5-242-16

Delicate Dissecting Scissors
slender pattern

16.5 cm



Metzenbaum-Fino
SST-5-243-14

Delicate Dissecting Scissors
slender pattern

14.5 cm

Scissors



Metzenbaum-Fino

SST-5-244-14

Delicate Dissecting Scissors

14.5 cm



Metzenbaum-Fino

SST-5-245-14

Delicate Dissecting Scissors

<
14.5 cm



Metzenbaum-Fino

SST-5-246-14

Delicate Dissecting Scissors

14.5 cm

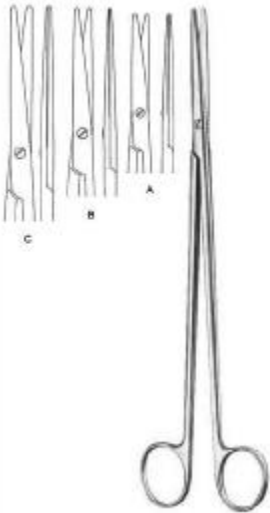

Metzenbaum-Fino

SST-5-247-18

Delicate Dissecting Scissors
slender pattern

18 cm, 20cm, 23 cm

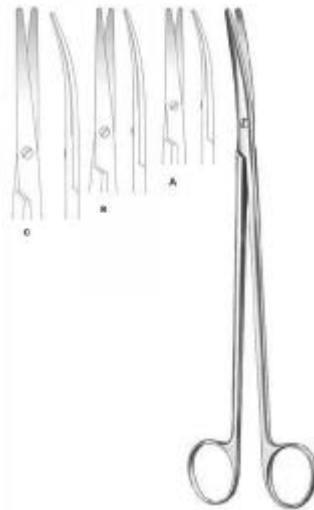

Metzenbaum-Fino

SST-5-248-18

Delicate Dissecting Scissors
slender pattern

18 cm, 20cm, 23 cm

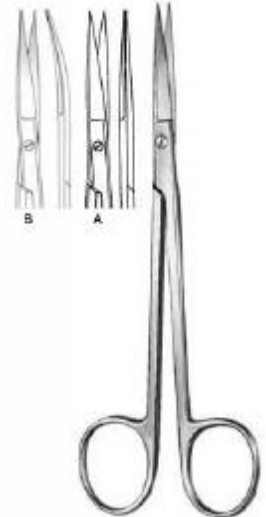

Sanvenero

SST-5-250-14

Operating Scissors

14 cm

Scissors

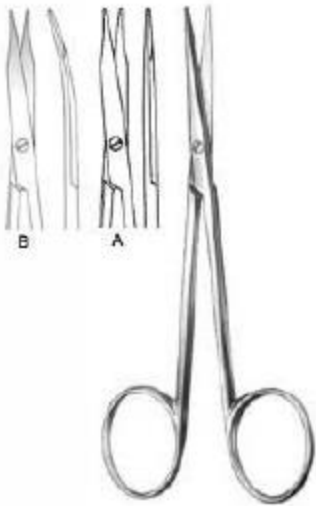

Fine Operating Scissors
SST-5-251-11
Fine Operating Scissors
11.5cm

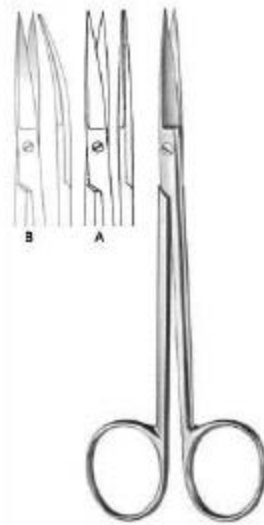

Joseph
SST-5-252-14
Operating Scissors
14.5 cm

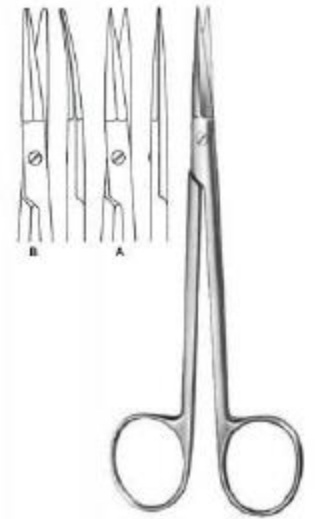

Peck-Joseph
SST-5-253-14
Face-lift Scissors
14.5 cm

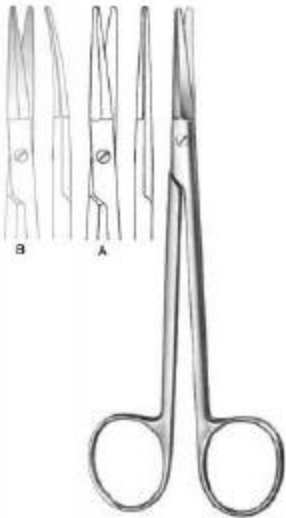

Peck-Joseph
SST-5-254-14
Face-lift Scissors
14.5 cm



Shea Vein Graft
SST-5-255-12
Dissecting Scissors
12 cm

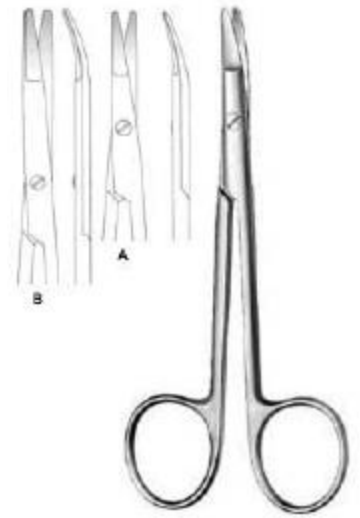

Kilner
SST-5-256-12
Dissecting Scissors
12 cm, 15 cm

Scissors

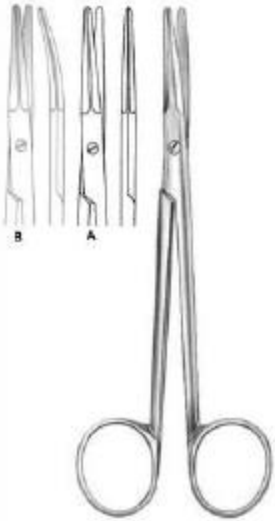

Dissecting Scissors
SST-5-257-14
Dissecting Scissors
14.5 cm

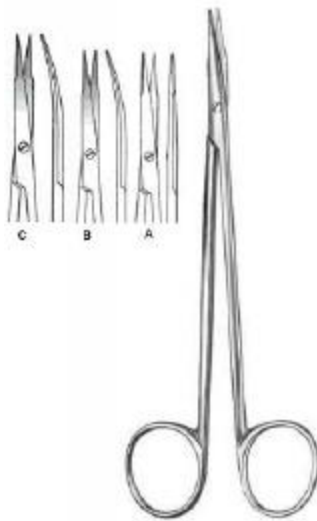

Reynolds
SST-5-258-15
Dissecting Scissors
15.5 cm, 18 cm



Jameson
SST-5-259-14
Dissecting Scissors
15.5 cm



Jameson
SST-5-260-14
Dissecting Scissors
15.5 cm



Vascular Scissors
SST-5-261-19
Vascular Scissors
19 cm



Vascular Scissors
SST-5-262-24
Vascular Scissors
19 cm , 25.5 cm

Scissors

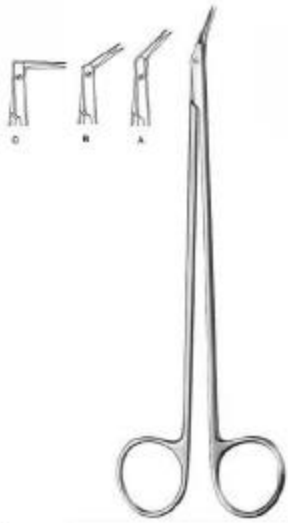

Diethrich

SST-5-263-25

Vascular Scissors

17.5 cm, 18.5 cm , 19 cm

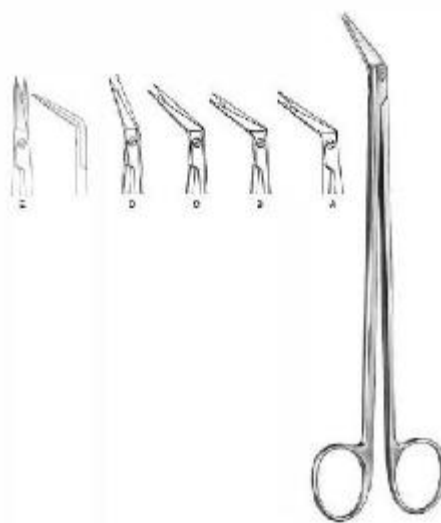

DeBakey

SST-5-264-45

Vascular Scissors

16 cm, 16.5 cm



Potts-Smith

SST-5-265-19

Vascular Scissors

18 cm, 18.5 cm , 19 cm



Coronary Scissors

SST-5-267-45

Cardiovascular Surgery Scissors

18 cm



Coronary Scissors

SST-5-267-45

Cardiovascular Surgery Scissors

18 cm



Coronary Scissors

SST-5-268-60

Cardiovascular Surgery Scissor

18 cm



Coronary Scissors
SST-5-269-90
Cardiovascular Surgery Scissor

18 cm



Coronary Scissors
SST-5-270-00
Cardiovascular Surgery Scissor

18 cm



Coronary Scissors
SST-5-271-00
Cardiovascular Surgery Scissor

18 cm



Coronary Scissors
SST-5-272-25
Cardiovascular Surgery Scissor

18 cm



Coronary Scissors
SST-5-273-45
Cardiovascular Surgery Scissor

18 cm



Coronary Scissors
SST-5-274-90
Cardiovascular Surgery Scissor

18 cm

Scissors



Schmieden-Taylor
SST-5-275-17

Dura Scissors

15 cm



Strully
SST-5-276-22

Neurosurgical Scissors

22.5 cm



Toennis-Adson
SST-5-277-17

Dissecting Scissors

17.5 cm



Good
SST-5-279-19

Tonsil Scissors

19.5 cm



Fomon
SST-5-282-15

Nasal Scissors

15 cm



Cottle
SST-5-283-16

Nasal Scissors

16 cm

Scissors



Heymann
SST-5-284-18

Nasal Scissors

18.5 cm



Heymann
SST-5-285-18

Nasal Scissors

18.5 cm



Converse
SST-5-286-11

Nasal Scissors blunt & sharp

10.5 cm



Waldmann
SST-5-287-18

Episiotomy Scissors

18 cm



Braun-Stadler
SST-5-268-60

Episiotomy Scissors

14.5 cm



Braun-Stadler
SST-5-289-22

Episiotomy Scissors

22cm

Scissors



Modell USA
SST-5-290-10

Umbilical Scissors

10.5 cm



Busch
SST-5-292-16

Umbilical Scissors

16 cm



Goldmann-Fox
SST-5-293-13

Gum Scissors

13cm



Wagner
SST-5-294-12

Operating Scissors

12 cm

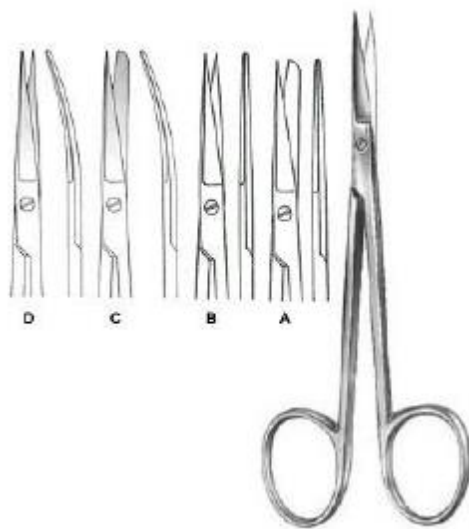

Operating Scissors
SST-5-295-12

Operating Scissors small model

12 cm



La Grange
SST-5-296-11

Gum Scissors S-shaped

11.5cm

Scissors



Dissecting Scissors

SST-5-297-11

Dissecting Scissors

11.5cm



Locklin

SST-5-298-16

Gum Scissors

16 cm



Locklin

SST-5-299-16

Gum Scissors

16 cm



Operating Scissors

SST-5-300-08

Operating Scissors

9

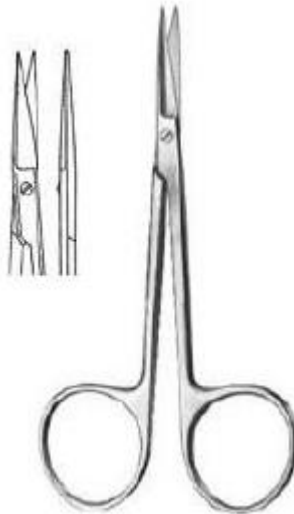

Iris Scissors

SST-5-301-10

Iris Scissors

9 cm, 10 cm

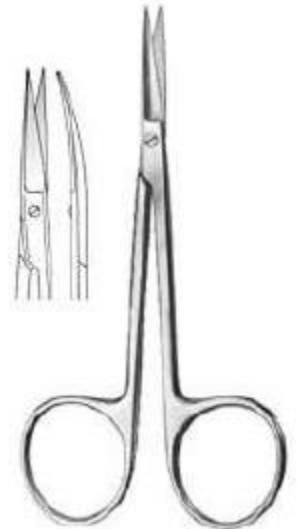

Iris Scissors

SST-5-302-10

Iris Scissors

10 cm

Scissors



Iris Scissors
SST-5-303-10
Iris Scissors
10 cm



Bonn
SST-5-304-09
Iris Scissors



Dean
SST-5-278-17
Tonsil Scissors
17.5 cm



Spencer Scissor
SST-0-
Spencer Scissor

Dressing & Tissue Forceps



Standard
SST-5-401-10

Dressing Forceps

10.5 cm , 11.5cm, 13cm, 14.5 cm , 16 cm,
18 cm, 20cm, 23 cm , 25 cm , 30.5 cm



Standard
SST-5-402-11

Dressing Forceps

12 cm, 13cm, 14.5 cm , 16 cm, 18 cm,
20cm, 25 cm , 30 cm



Dressing Forceps
SST-5-403-13

Dressing Forceps

13cm, 14.5 cm



Stille
SST-5-404-15

Dressing Forceps

15 cm



Mini-Adson
SST-5-405-12

Dressing Forceps

12 cm



Adson
SST-5-406-12

Dressing Forceps

12 cm, 15 cm

Dressing & Tissue Forceps



McIndoe
SST-5-405-12

Dressing Forceps

15 cm



Waugh
SST-5-408-20

Dressing Forceps

20cm



Semken
SST-5-409-12

Dressing Forceps

12.5 cm, 15 cm



Taylor
SST-5-410-17

Dressing Forceps

12.5 cm, 15 cm



Taylor
SST-5-411-17

Dressing Forceps

17 cm



Taylor
SST-5-412-17

Dressing Forceps

18.5 cm

Dressing & Tissue Forceps



Dressing Forceps
SST-5-413-06
Dressing Forceps
15.5 cm



Gerald
SST-5-414-18
Dressing Forceps
15.5 cm



Cushing
SST-5-415-17
Dressing Forceps
17.5 cm



Potts-Smith
SST-5-416-18
Dressing Forceps
18 cm, 21cm, 24.5 cm



Bonney
SST-5-417-17
Dissecting Forceps
17.5 cm



Gerald
SST-5-418-17
17.5 cm

Dressing & Tissue Forceps



Gillies

SST-5-419-15

Dissecting Forceps

15.5 cm



McIndoe

SST-5-420-15

Dressing Forceps

15 cm



Semken

SST-5-421-16

Dissecting Forceps

15.5 cm, 17.5 cm



Adson-Brown

SST-5-422-12

Dissecting Forceps

12 cm



Adson

SST-5-423-12

Dissecting Forceps

12 cm, 15 cm



Adson

SST-5-424-12

Dressing Forceps

12 cm, 15 cm

Dressing & Tissue Forceps



Cushing
SST-5-425-17

Dressing Forceps

17.5 cm



Cushing
SST-5-426-18

Dressing Forceps

17 cm



Cushing-Taylor
SST-5-427-18

Dressing Forceps

18.5 cm



Potts-Smith
SST-5-428-15

Dressing Forceps

16 cm, 18.5 cm, 20cm, 23 cm, 25 cm



Oehler
SST-5-429-14

Dissecting Forceps

14.5 cm, 16 cm, 18 cm, 20cm, 25 cm



Wangensteen
SST-5-430-15

Dressing Forceps

15 cm, 23 cm

Dressing & Tissue Forceps



DeBakey
SST-5-421-16
 Atraumatic Dressing Forceps
 16 cm, 20cm, 24.5 cm



DeBakey
SST-5-432-16
 Atraumatic Dressing Forceps
 16 cm, 20cm, 24 cm



Dissecting Forceps
SST-5-433-10
 Dissecting Forceps
 10.5 cm , 11.5cm, 13 cm , 14.5 cm , 16 cm,
 18 cm, 20cm, 23 cm , 25 cm , 30.5 cm

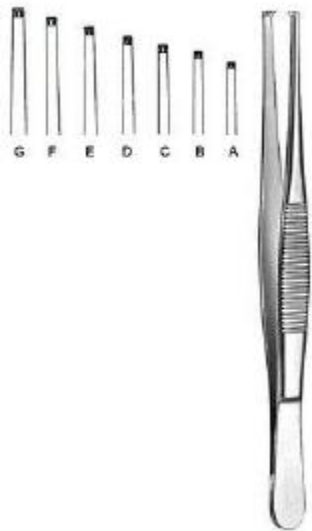

Dissecting Forceps
SST-5-434-11
 Dissecting Forceps
 12 cm, 13 cm , 14.5 cm , 15.5 cm, 18 cm,
 20cm, 24.5 cm



Dissecting Forceps
SST-5-435-14
 Dissecting Forceps
 14.5 cm , 16 cm



Dissecting Forceps
SST-5-436-14
 Dissecting Forceps
 14.5 cm , 16 cm

Dressing & Tissue Forceps



Dissecting Forceps
SST-5-437-13

Dissecting Forceps

13 cm , 14.5 cm , 16 cm, 20cm



Dissecting Forceps
SST-5-438-13

Dissecting Forceps

13 cm , 14.5 cm



Stille
SST-5-439-15

Dissecting Forceps

15 cm



Stille
SST-5-440-15

Dissecting Forceps

15 cm



Stone
SST-5-441-15

Dissecting Forceps

15 cm



Lerche
SST-5-442-15

Dissecting Forceps

15 cm

Dressing & Tissue Forceps



Adlerkreutz

SST-5-443-15

Dissecting Forceps

15.5 cm, 20.5 cm, 16 cm, 20cm, 25 cm

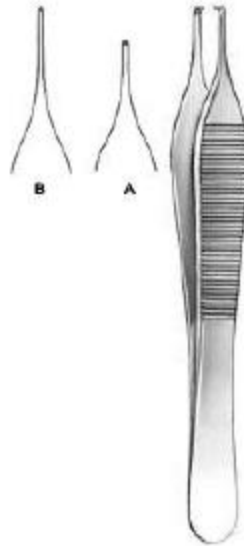

Adson

SST-5-444-12

Dissecting Forceps

12 cm, 15 cm



Gillies

SST-5-445-15

Dissecting Forceps

15.5 cm



Waugh

SST-5-446-20

Dissecting Forceps

20.5 cm



Semken

SST-5-447-12

Dissecting Forceps

12.5 cm, 15 cm



Taylor

SST-5-448-17

Dissecting Forceps

17.5 cm

Dressing & Tissue Forceps



Taylor
SST-5-449-17
Dissecting Forceps
17 cm



Taylor
SST-5-450-17
Dissecting Forceps
18.5 cm



Dissecting Forceps
SST-5-451-06
Dissecting Forceps
15.5 cm



Gerald
SST-5-452-17
Dissecting Forceps
17.5 cm



Cushing
SST-5-453-17
Dissecting Forceps



Potts-Smith
SST-5-454-18
Dissecting Forceps
18 cm, 21cm, 24 cm

Dressing & Tissue Forceps

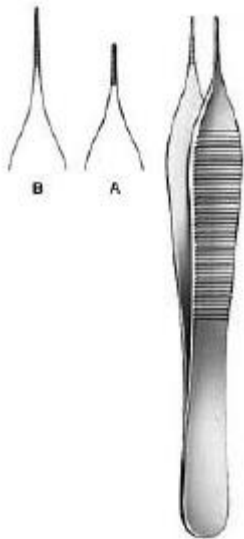

Mikro-Adson
SST-5-455-12

Dressing Forceps

12 cm, 15 cm

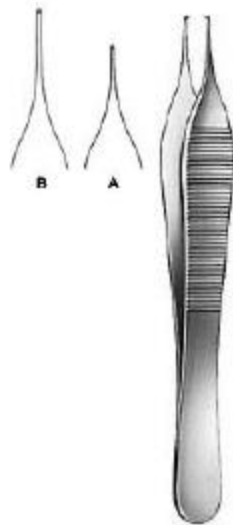

Mikro-Adson
SST-5-456-12

Dissecting Forceps

12 cm, 15 cm



Dissecting Forceps

SST-5-457-11

Dissecting Forceps

10.5 cm



Micro Jewelers
SST-5-458-12

Jeweler Type Forceps

12 cm Fig. 7



Jewelers
SST-5-459-12

Jeweler Type Forceps

12 cm Fig. 3



Jewelers
SST-5-460-11

Jeweler Type Forceps

11 cm Fig. 3c

Dressing & Tissue Forceps



Jewelers
SST-5-461-11

Jeweler Type Forceps

11 cm Fig. 5



Jewelers
SST-5-462-11

Jeweler Type Forceps

11 cm Fig. 4



Stille-Barraya
SST-5-463-18

Dissecting Forceps

18 cm



Bonney
SST-5-464-18

Dissecting Forceps

17.5 cm



Nelson
SST-5-465-23

Dissecting Forceps

23 cm



Dressing Forceps
SST-5-466-10

Dressing Forceps

10 cm , 9.5 cm

Dressing & Tissue Forceps



Splinter Forceps Smooth Jaw

SST-5-467-12

Splinter Forceps smooth jaw

12.5 cm



Splinter Forceps Smooth Jaw

SST-5-468-12

Splinter Forceps smooth jaw

12.5 cm



Splinter Forceps

SST-5-469-12

Splinter Forceps

12.5 cm



Splinter Forceps

SST-5-470-12

Splinter Forceps

12.5 cm



Micro Tying Forceps

SST-5-471-16

Micro Tying Forceps

15.5 cm



Microscopic Forceps Super Light, Blunt

SST-5-472-10

Microscopic Forceps super light, blunt

10 cm

Dressing & Tissue Forceps



Microscopic Forceps
SST-5-473-10
Microscopic Forceps
10 cm



Shaaf
SST-5-474-09
Splinter Forceps
9.5 cm



Littauer
SST-5-475-08
Cilia Forceps
8.5 cm



Cilia Forceps
SST-5-476-09
Cilia Forceps
8.5 cm



Douglas
SST-5-477-09
Cilia Forceps
9 cm



Douglas
SST-5-478-09
Cilia Forceps
9 cm

Dressing & Tissue Forceps



Beer
SST-5-479-09
Cilia Forceps
9 cm

Splinter Forceps



Phaneuf
SST-5-501-21
Hysterectomy Forceps
20.5 cm



Wertheim-Cullen
SST-5-502-21
Vaginal Clamp
21 cm

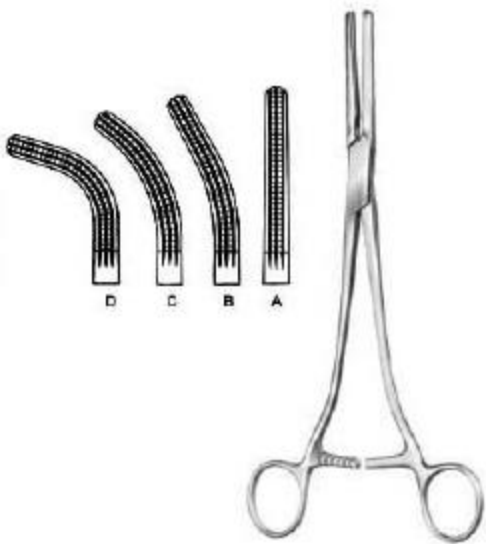

Rogers
SST-5-503-10
Hysterectomy Forceps
21.5 cm Fig. 1, 21 cm Fig. 2, 20.5 cm Fig. 3,
20 cm Fig. 4



Moynihan
SST-5-504-23
Hysterectomy Forceps
23 cm



Moynihan
SST-5-505-24
Hysterectomy Forceps
23.5 cm



Wertheim
SST-5-506-25
Hysterectomy Forceps
26 cm

Splinter Forceps

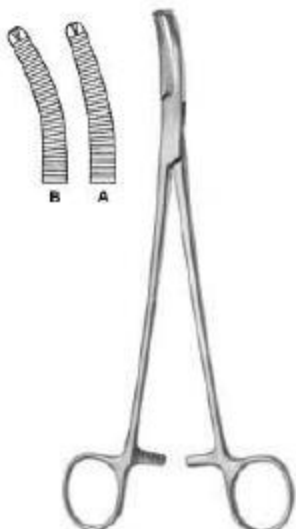

Wertheim
SST-5-507-22
Hysterectomy Forceps
22.5 cm



Mikulicz, Baby
SST-5-508-14
Peritoneum Forceps
14.5 cm



Mikulicz
SST-5-509-18
Peritoneum Forceps
20.5 cm



Mikulicz
SST-5-510-20
Peritoneum Forceps
18.5 cm



Mikulicz
SST-5-511-20
Peritoneum Forceps
20cm



Mikulicz
SST-5-512-21
Peritoneum Forceps
20.5 cm



Faure
SST-5-513-20
Peritoneum Forceps
21 cm

Haemostatic Forceps

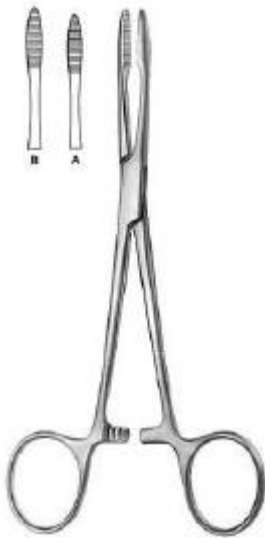

Pean

SST-5-601-14

Haemostatic Forceps

14.5 cm , 16 cm



Spencer-Wells

SST-5-602-13

Haemostatic Forceps

13 cm , 14 cm, 15.5 cm, 18.5 cm , 20 cm



Spencer-Wells

SST-5-603-13

Haemostatic Forceps

13 cm , 14 cm, 15 cm, 18 cm, 20 cm



Chaput

SST-5-604-13

Haemostatic Forceps

12.5 cm



Tuffier

SST-5-605-13

Haemostatic Forceps

12.5 cm

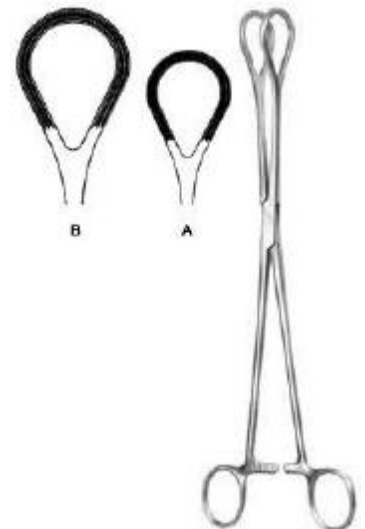

Grasping Forceps

SST-5-606-25

Organ Grasping Forceps

Haemostatic Forceps



Collin
SST-5-607-14
Organ Grasping Forceps
12.5 cm, 21 cm



Collin
SST-5-608-17
Tumor Grasping Forceps
17 cm



Pennington
SST-5-609-15
Haemostatic Forceps
15.5 cm



Pratt
SST-5-610-15
Haemostatic Forceps
15 cm



Martel-Rees
SST-5-611-14
Face-lift Forceps
13.5 cm



Ligature Forceps
SST-5-612-12
Ligature Forceps

Haemostatic Forceps



Mixer-Baby
SST-5-613-01

Dissecting and Ligature Forceps

13 cm , 13.5 cm

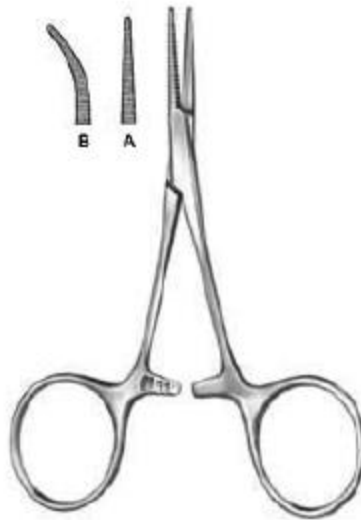

Hartmann
SST-5-614-10

Haemostatic Forceps

9.5 cm, 10 cm



Ligature Forceps
SST-5-615-12

Ligature Forceps

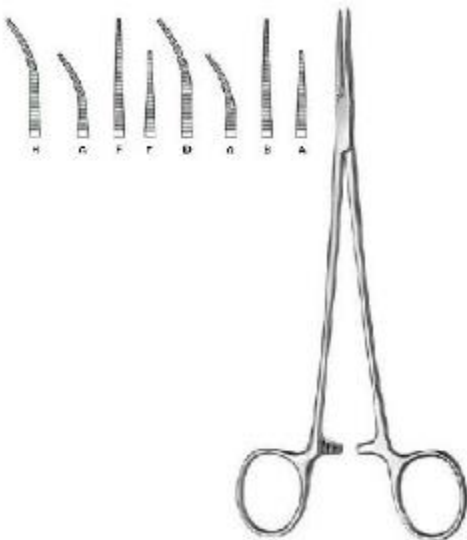

Halsted-Mosquito
SST-5-616-18

Haemostatic Forceps

12.5 cm, 14 cm, 14.5 cm

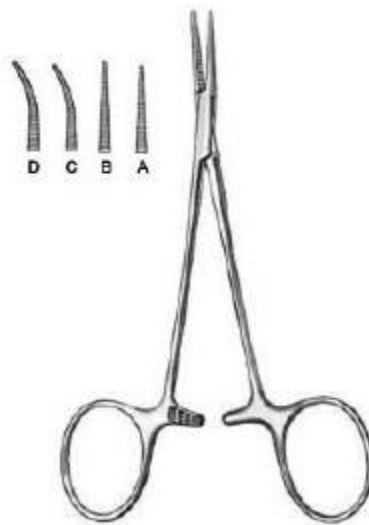

Mikro-Mosquito
SST-5-617-10

Haemostatic Forceps

9.5 cm, 10 cm , 11.5 cm, 12 cm



Providence-Hospital
SST-5-618-14

Haemostatic Forceps

14 cm

Haemostatic Forceps



Leriche

SST-5-619-15

Haemostatic Forceps

15 cm, 15.5 cm

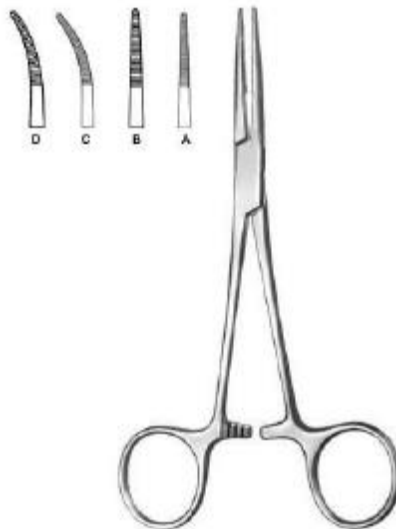

Kelly

SST-5-620-14

Haemostatic Forceps

14 cm, 14.5 cm



Kelly-Rankin

SST-5-621-16

Haemostatic Forceps

15.5 cm, 16 cm



Overholt-Baby

SST-5-622-14

Dissecting and Ligature Forceps

14 cm, 14.5 cm



Crile

SST-5-623-14

Haemostatic Forceps

14 cm, 14.5 cm



Crile-Rankin

SST-5-624-16

Haemostatic Forceps

16 cm, 16.5 cm

Haemostatic Forceps



Lovelace
SST-5-625-15
Haemostatic Forceps
16 cm



Dandy-Mosquito
SST-5-626-12
Haemostatic Forceps
12 cm

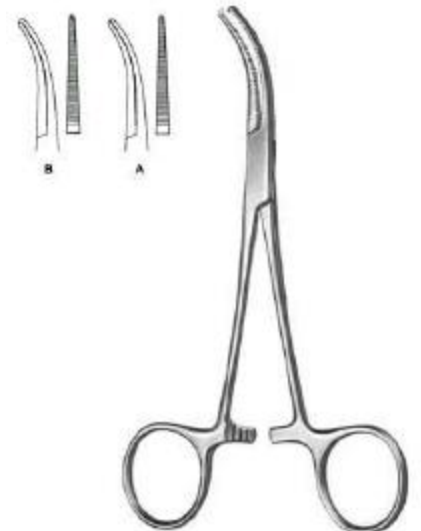

Dandy
SST-5-627-14
Haemostatic Forceps
14 cm, 14.5 cm



Schmidt
SST-5-628-18
Dissecting and Ligature Forceps
18.5 cm , 19 cm



Adson
SST-5-629-18
Dissecting and Ligature Forceps
18.5 cm , 19 cm



Martin-Fuchsig
SST-5-630-20
Dissecting and Ligature Forceps
20.5 cm

Haemostatic Forceps



Rochester-Carmalt

SST-5-631-16

Haemostatic Forceps

16.5 cm , 17 cm , 20 cm, 20.5 cm

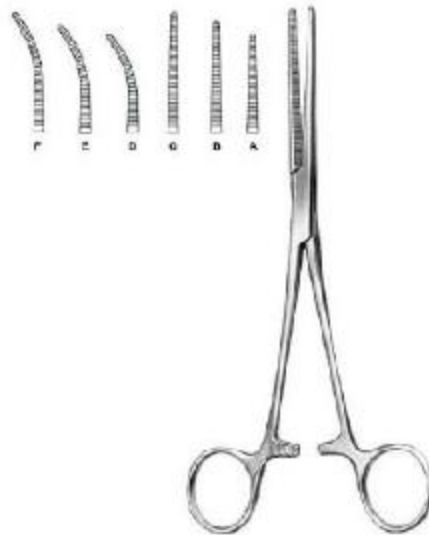

Pean

SST-5-632-13

Haemostatic Forceps

13 cm , 13.5 cm , 14 cm, 14.5 cm , 16.5 cm, 17 cm

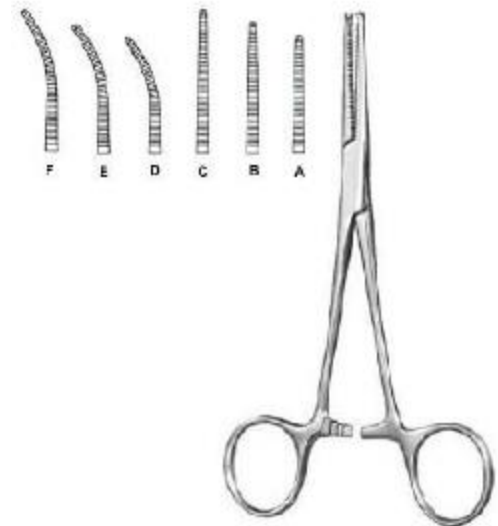

Kocher-Nippon

SST-5-633-14

Haemostatic Forceps

14.5 cm , 16 cm, 16.5 cm, 18 cm, 18 cm

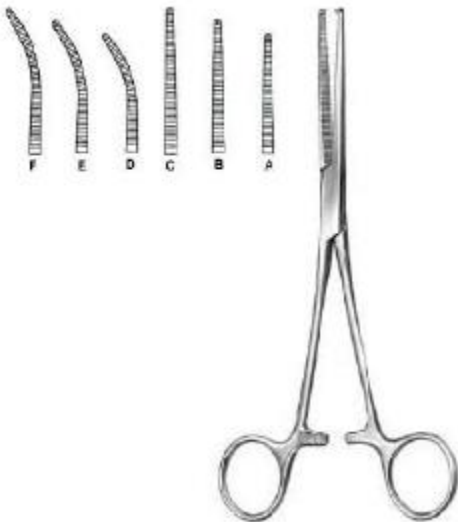

Kocher

SST-5-635-13

Haemostatic Forceps

13 cm , 14 cm, 16 cm

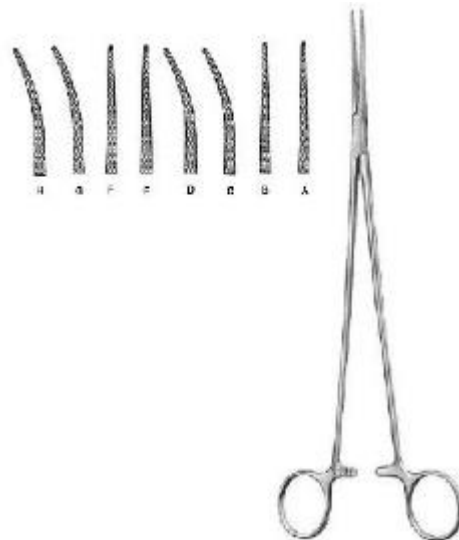

Bengolea

SST-5-636-20

Haemostatic Forceps

21 cm, 21.5 cm, 26 cm

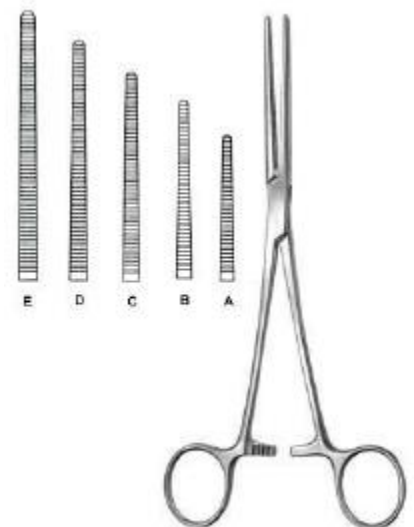

Pean (Rochester)

SST-5-637-14

Haemostatic Forceps

14 cm, 14.5 cm , 16 cm, 16.5 cm, 18.5 cm , 20.5 cm, 22.5 cm, 24.5 cm, 26 cm, 30.5 cm

Haemostatic Forceps

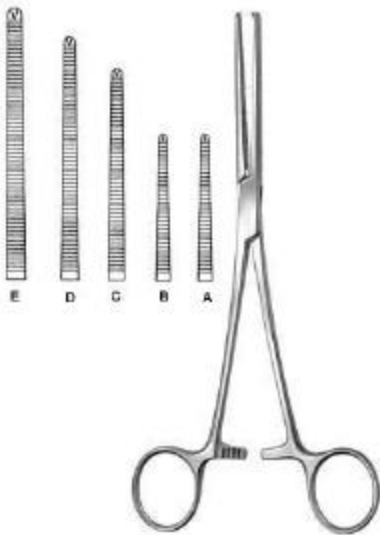

Kocher (Ochsner)

SST-5-638-14

Haemostatic Forceps

14.5 cm , 16.5 cm, 18.5 cm , 20.5 cm, 22.5 cm, 24.5 cm, 26 cm, 30.5 cm

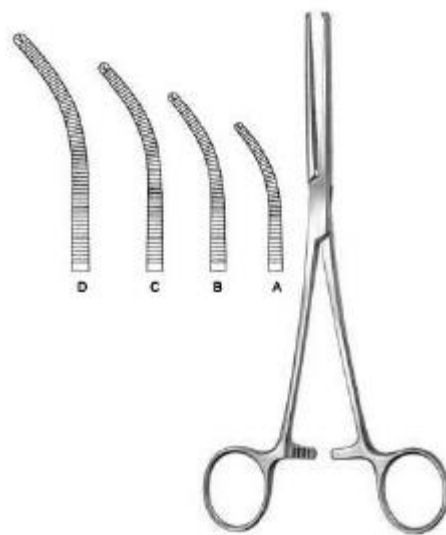

Kocher (Ochsner)

SST-5-639-14

Haemostatic Forceps

14 cm, 16 cm, 18 cm, 20 cm, 22 cm, 24 cm , 25.5 cm, 30 cm

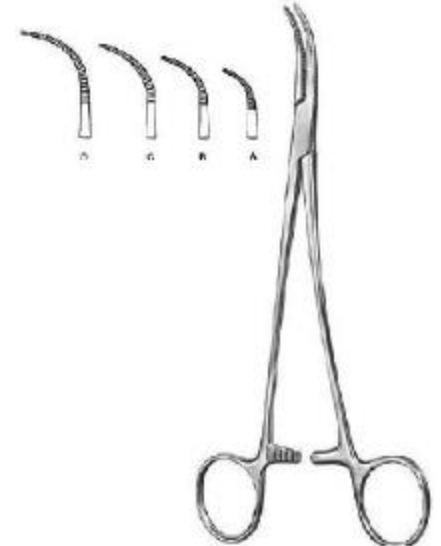

Overholt-Martin

SST-5-640-01

Dissecting and Ligature Forceps

18.5 cm Fig. 1 , 20.5 cm Fig. 2, 21 cm Fig. 3, 21.5 cm Fig. 4, 24.5 cm Fig. 5



Mixer-Baby

SST-5-641-18

Dissecting and Ligature Forceps

18.5 cm



Adson-Baby

SST-5-642-14

Dissecting and Ligature Forceps

14.5 cm , 18 cm



Heiss

SST-5-643-20

Dissecting and Ligature Forceps

20 cm, 20.5 cm, 21 cm

Haemostatic Forceps



Overholt-Mixer

SST-5-644-21

Dissecting and Ligature Forceps
21.5 cm

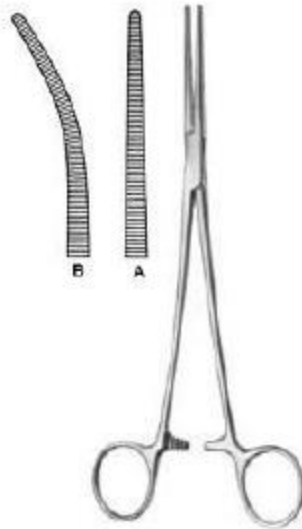

Roberts

SST-5-645-22

Dissecting and Ligature Forceps
21.5 cm, 22.5 cm

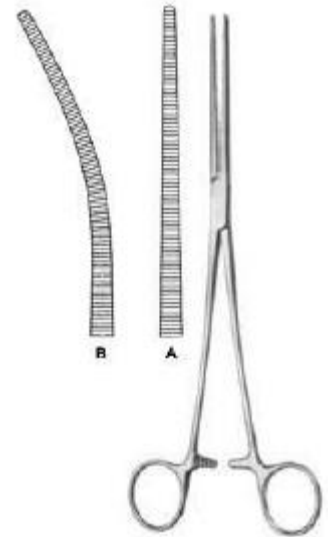

Sarot

SST-5-646-24

Dissecting and Ligature Forceps
24.5 cm, 25 cm



Crafoord

SST-647-18

Dissecting and Ligature Forceps
18 cm, 24.5 cm

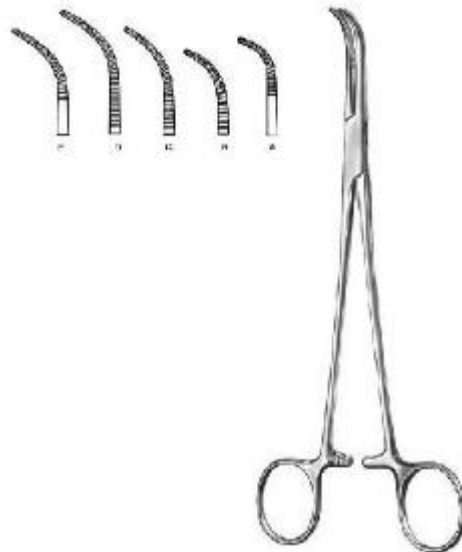

Overholt-Geissendorfer

SST-5-648-01

Dissecting and Ligature Forceps
20.5 cm Fig. 1 , 20 cm Fig. 2 , 21.5 cm Fig. 3 , 22 cm Fig. 4 , 21.5 cm Fig. 5 , 22 cm Fig. 6 , 27 cm Fig. 1 , 26.5 cm Fig. 2 , 27.5 cm Fig. 3 , 28 cm Fig. 4

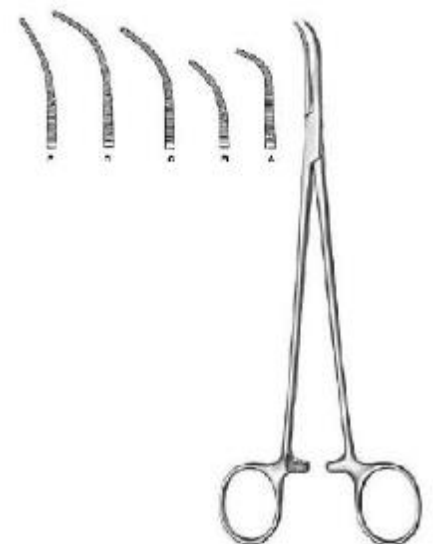

Overholt-Fino

SST-5-649-00

Dissecting and Ligature Forceps
21 cm, 21.5 cm, 22 cm, 22.5 cm, 23 cm

Haemostatic Forceps

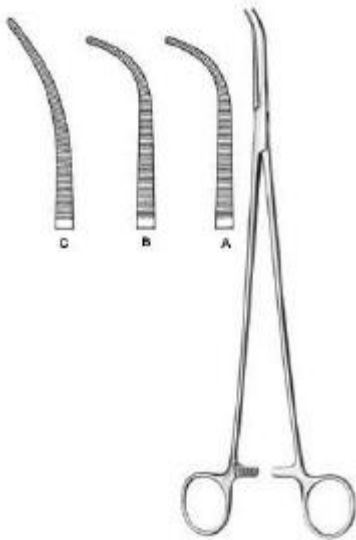

Overholt

SST-5-650-00

Dissecting and Ligature Forceps
29.5 cm, 30 cm



Overholt-Mini

SST-5-651-01

Dissecting and Ligature Forceps
15 cm, 20 cm

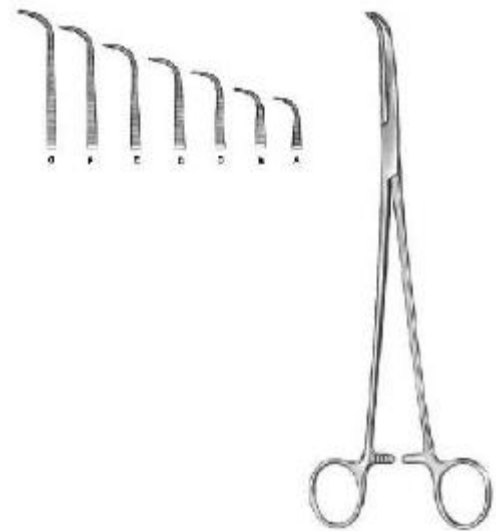

Gemini

SST-5-652-13

Dissecting and Ligature Forceps
13 cm , 16 cm, 18 cm, 21 cm, 23 cm , 25
cm , 28 cm

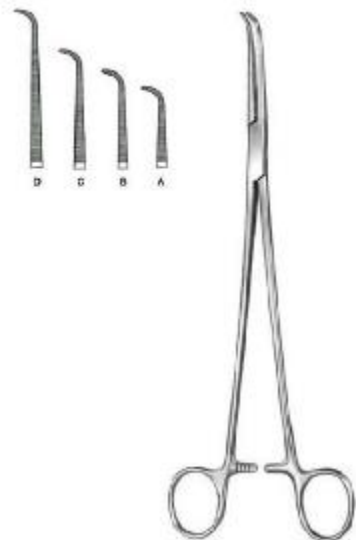

Mini-Gemini

SST-5-653-18

Dissecting and Ligature Forceps
18 cm, 22.5 cm, 25 cm , 28.5 cm

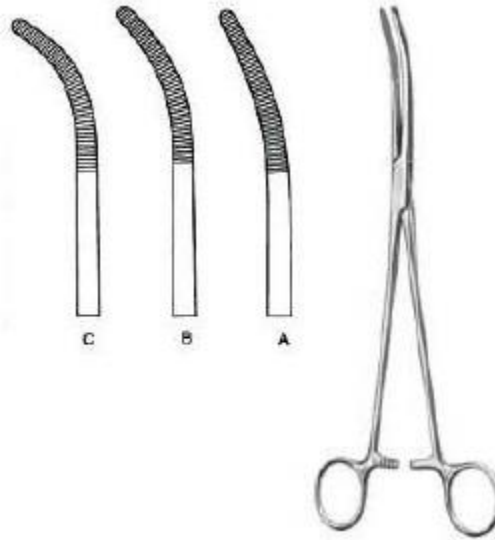

Rumel

SST-5-654-01

Dissecting and Ligature Forceps
24 cm Fig. 1 , 23.5 cm Fig. 2 , 23 cm Fig. 3,
24 cm Fig. 4 , 23.5 cm Fig. 5

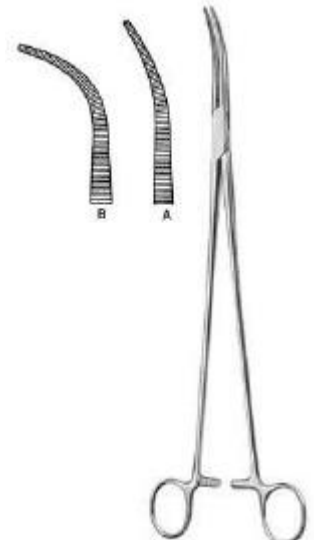

Zenker

SST-5-655-01

Dissecting and Ligature Forceps
28.5 cm, 29.5 cm

Haemostatic Forceps



Mixer-Baby
SST-5-656-14

Dissecting and Ligature Forceps
13.5 cm



Mixer
SST-5-657-15

Dissecting and Ligature Forceps
16 cm, 18 cm



Mixer-O Shaugnessy
SST-5-658-19

Dissecting and Ligature Forceps
18 cm



Mixer
SST-5-659-22

Dissecting and Ligature Forceps
22.5 cm



Mixer
SST-5-660-23

Dissecting and Ligature Forceps
23 cm



Wickstrom
SST-5-661-21

Dissecting and Ligature Forceps
21 cm, 24.5 cm

Haemostatic Forceps



Mixer

SST-5-662-22

Dissecting and Ligature Forceps
22.5 cm, 26 cm, 28 cm



Mc Quigg-Mixer

SST-5-663-22

Dissecting and Ligature Forceps
23.5 cm



Lower

SST-5-664-18

Dissecting and Ligature Forceps
18.5 cm



Lahey

SST-5-665-19

Bile Duct Clamp
19.5 cm, 22.5 cm



Finochietto

SST-5-666-24

Dissecting and Ligature Forceps
24 cm



Uro-Tangential

SST-5-667-01

Tangential Forceps
25 cm, 27 cm

Haemostatic Forceps

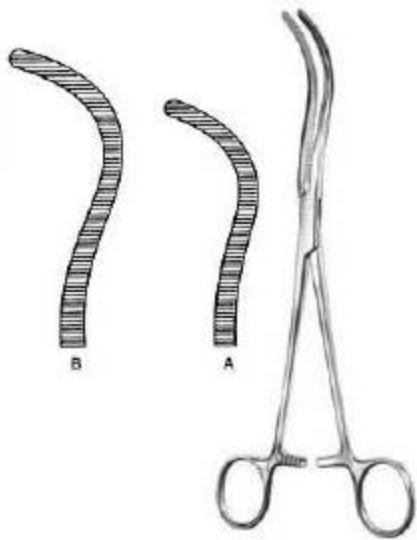

Guyon

SST-5-668-20

Kidney Pedicle Clamp

23 cm , 24 cm



Guyon

SST-5-669-23

Kidney Pedicle Clamp

19.5 cm , 21.5 cm, 24 cm



Desjardins

SST-5-670-21

Bile Duct Clamp

21 cm

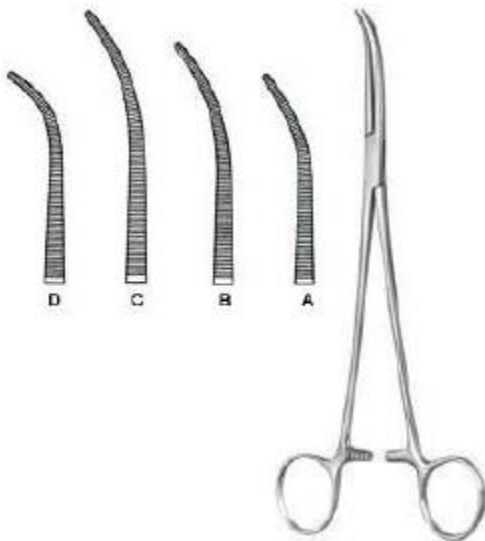

Kelly

SST-5-671-19

Dissecting and Ligature Forceps

19.5 cm Fig. 1 , 22.5 cm Fig. 1 , 24.5 cm Fig. 1 , 19 cm Fig. 2 , 22 cm Fig. 2 , 24 cm Fig. 2 , 18.5 cm Fig. 3 , 23.5 cm Fig. 3, 21.5 cm Fig.

3



Lawrence

SST-5-672-28

Dissecting and Ligature Forceps

28 cm



Meeker

SST-5-673-28

Dissecting and Ligature Forceps

28 cm



Negus

SST-5-674-19

Haemostatic Forceps

19.5 cm Fig. 1 , 20 cm Fig. 2

Towel & Tubing Clamps



Schaedel
SST-5-701-09
Towel Clamp sharp
9 cm



Jones
SST-5-702-05
Towel Clamp sharp
5.5 cm, 8.5 cm



Jones-Martin
SST-5-703-09
Towel Clamp sharp
8.5 cm



Backhaus
SST-5-705-11
Towel Clamp
11.5 cm



Backhaus
SST-5-706-08
Towel Clamp
9 cm, 11.5 cm, 13 cm, 16 cm



Peers-Bertram Modif.
SST-5-707-15
Towel Clamp wide jaw for tube fixation
18.5 cm

Towel & Tubing Clamps



R?Der
SST-5-708-13
Towel Clamp
13.5 cm

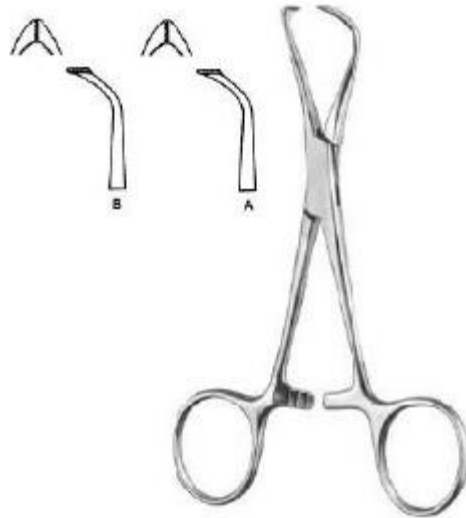

Lorna
SST-5-709-10
Towel Clamp fine serrated, wide jaw
9.5 cm, 13 cm



Bernhard
SST-5-710-16
Towel Clamp
16.5 cm

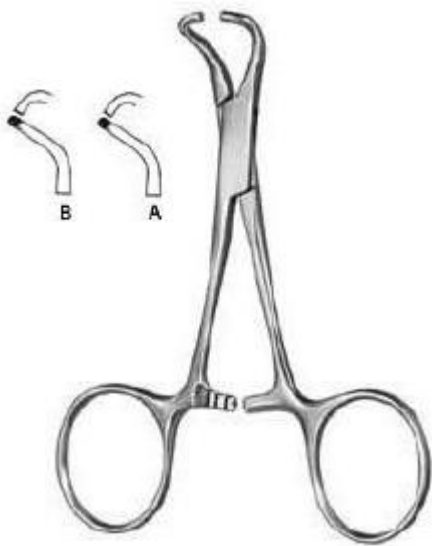

Tohoku
SST-5-711-10
Towel Clamp
10.5 cm blunt, 13.5 cm blunt, 14.5 cm

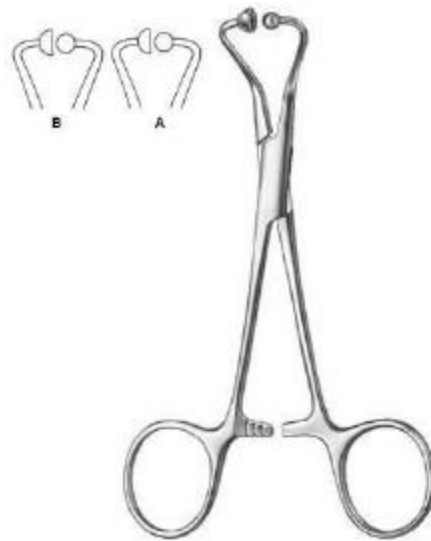

Towel Clamp For Paper Clothes
SST-5-712-11
Towel Clamp for paper clothes
11.5 cm, 14 cm



Lane
SST-5-713-20
Lane
19.5 cm

Towel & Tubing Clamps



Tube Holder For Fixation Of Six Tubes
SST-5-714-06
 Tube Holder for fixation of six tubes



Tubing Clamp Extra Long Ratchet
SST-5-715-14
 Tubing Clamp extra long ratchet
 14 cm



Tubing Clamp
SST-5-716-16
 Tubing Clamp
 16.5 cm

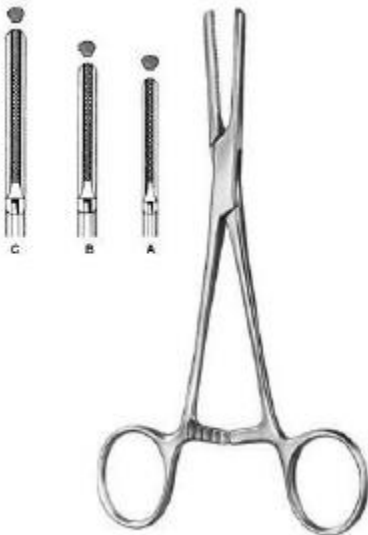

Tubing Clamp
SST-5-717-15
 Tubing Clamp
 15.5 cm , 19 cm , 20.5 cm

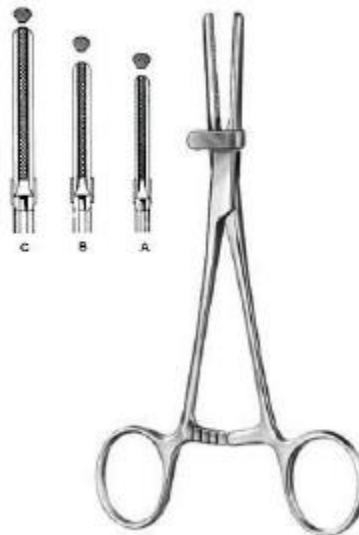

Tubing Clamp With Safety Guard
SST-5-718-15
 Tubing Clamp with safety guard
 15.5 cm , 19 cm , 20.5 cm

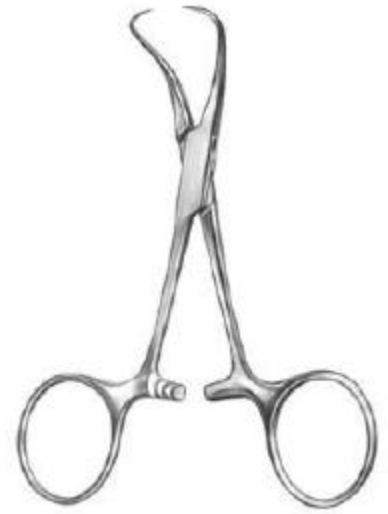

Backhaus
SST-5-704-11
 Towel Clamp
 11.5 cm , 13 cm

Dressing & Sponge Forceps

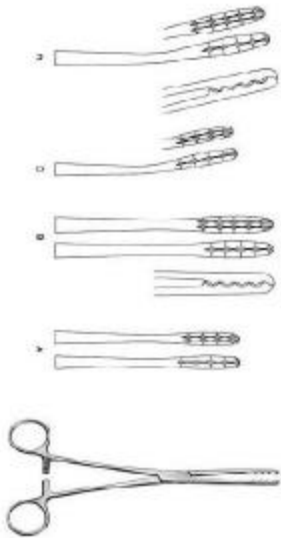

Ulrich
SST-5-801-22
Dressing Forceps
21.5 cm, 26.5 cm



Lister
SST-5-802-13
Sinus Forceps
13 cm, 16 cm, 18 cm



Martin
SST-5-803-17
Dressing Forceps
17.5 cm, 17 cm

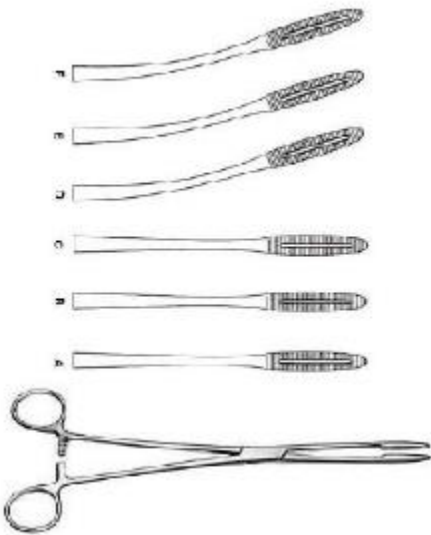

Gross-Maier
SST-5-804-20
Dressing Forceps
20.5 cm, 22 cm, 26.5 cm, 20 cm, 21.5 cm,
26 cm



Tunneling Forceps
SST-5-805-40
Tunneling Forceps
39.5 cm



Collin
SST-5-806-25
Dressing Forceps
25.5 cm

Dressing & Sponge Forceps



Cheron
SST-5-807-25
Dressing Forceps
23.5 cm



Bozemann
SST-5-808-26
Sponge Forceps
26 cm



Foerster
SST-5-809-25
Sponge Forceps
25 cm , 18 cm, 20.5 cm, 24.5 cm, 17.5 cm,
20 cm, 24.5 cm

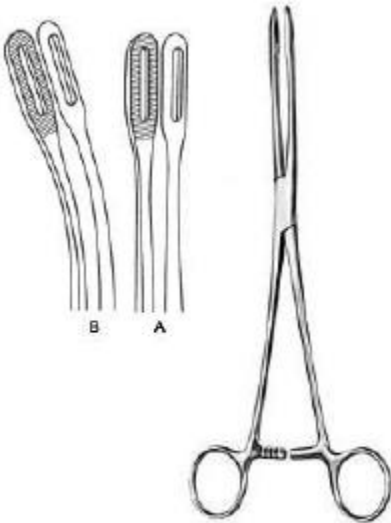

Foerster
SST-5-810-25
Sponge Forceps
25 cm , 24.5 cm



Rampley
SST-5-811-18
Sponge Forceps
18.5 cm , 24.5 cm

Retractors



Vickers
SST-5-901-18
Skin Hooklet
18.5 cm



Vickers
SST-5-902-01
Bone Hooklet
17 cm



Vickers
SST-5-903-01
Tendon Hooklet
17 cm



Vickers
SST-5-904-02
Hooklet
16 cm

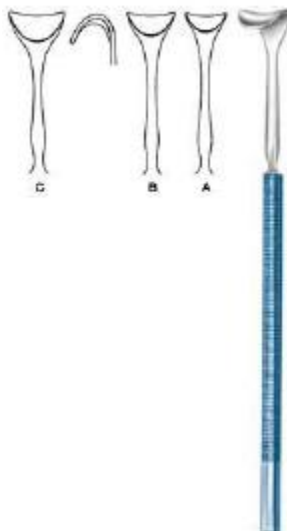

Vickers
SST-5-905-12
Saddle Hook
14 cm



Graefe
SST-5-906-01
Micro Hooklet
15 cm

Retractors

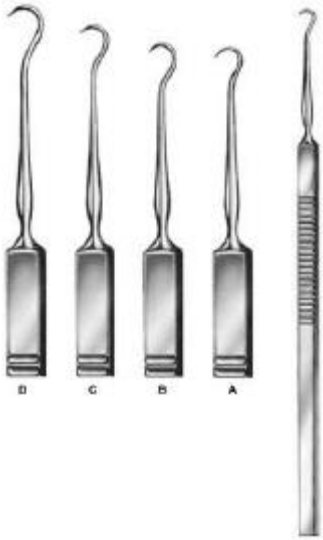

Skin Hook
SST-5-907-01

Skin Hook
16 cm Fig. 1, 16 cm Fig. 2, 16 cm Fig. 3, 16 cm Fig. 4



O Connor
SST-5-908-16

Skin Hook
16 cm



Guthrie
SST-5-909-01

Skin Hook
15.5 cm



Hooklet
SST-5-910-01

Hooklet
16.5 cm



Hooklet
SST-5-911-01

Hooklet
16.5 cm



Hooklet
SST-5-912-02

Hooklet
16 cm

Retractors



Hooklet
SST-5-913-04
Hooklet
16.5 cm



Vessel Hook
SST-5-914-12
Vessel Hook
12 cm



Desmarres
SST-5-915-08
Saddle Hook
16 cm 8 mm, 16 cm 10 mm, 16 cm 12 mm,
16 cm 14 mm, 16 cm 16 mm, 16 cm 18 mm

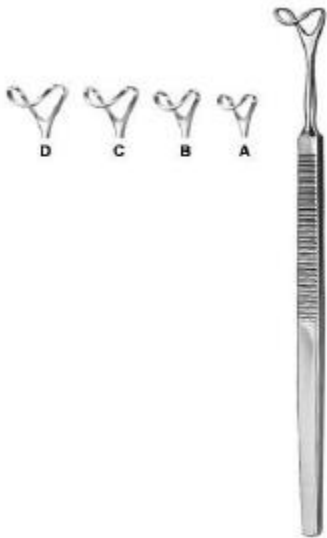

Saddle Hook
SST-5-916-12
Saddle Hook
16 cm 12 mm, 16 cm 14 mm, 16 cm 16
mm, 16 cm 18 mm



Langenbeck-Mini
SST-5-917-10
Langenbeck-Mini
16 cm



Hooklet
SST-5-918-16
Hooklet
16 cm 14 x 8

Retractors



Hooklet
SST-5-919-01
Hooklet
16.5 cm



Hooklet
SST-5-920-01
Hooklet
16.5 cm



Meyerding
SST-5-921-01
Hooklet
17.5 cm Fig. 1, 17.5 cm Fig. 2, 17.5 cm Fig. 3, 17.5 cm Fig. 4, 17.5 cm Fig. 5, 17.5 cm Fig. 6



Senn-Green
SST-5-922-01
Hooklet
15 cm Fig. 1, 15 cm Fig. 2



Ragnell-Davis
SST-5-923-14
Hooklet
14 cm

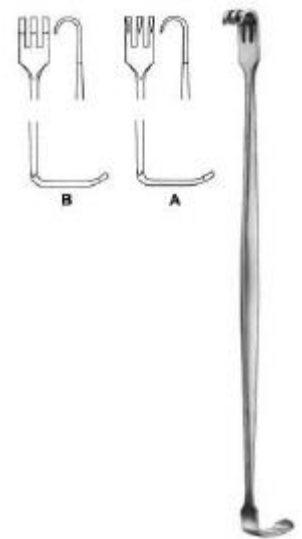

Senn-Miller
SST-5-924-16
Hooklet
16 cm

Retractors



Cushing
SST-5-925-20
Cushing
20.5 cm



Cushing
SST-5-926-08
Saddle Hook
20.5 cm 8 mm wide , 20.5 cm 10 mm wide,
20.5 cm 12 mm wide, 20.5 cm 14 mm wide,
20.5 cm 16 mm wide, 20.5 cm 18 mm wide



Cushing
SST-5-927-08
Saddle Hook 8 mm to 18 mm wide
24 cm



Brom
SST-5-928-01
Vein Hook
19.5 cm



Strandell-Stille
SST-5-929-01
Strandell-Stille
19 cm Fig. 1, 19 cm Fig. 2



Klapp
SST-5-930-01
Retractor 12 x 6, 12 x 11, 15 x 11
17.5 cm

Retractors



Hooklet
SST-5-931-04
Hooklet
16.5 cm

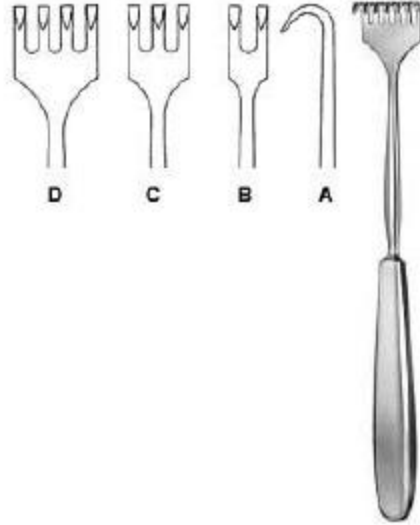

Volkmann
SST-5-932-01
Retractor
21.5 cm



Volkmann
SST-5-933-01
Retractor
22 cm, 21.5 cm



Kocher
SST-5-934-01
Retractor
22 cm

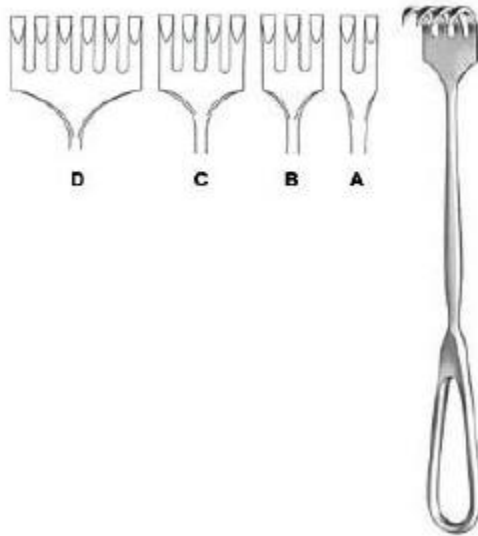

Martin
SST-5-935-02
Retractor
22.5 cm



Ollier
SST-5-936-03
Retractor
23 cm 36 x 30, 23 cm 36 x 60

Retractors



Wassmund
SST-5-937-02
Retractor
20.5 cm 33 x 21

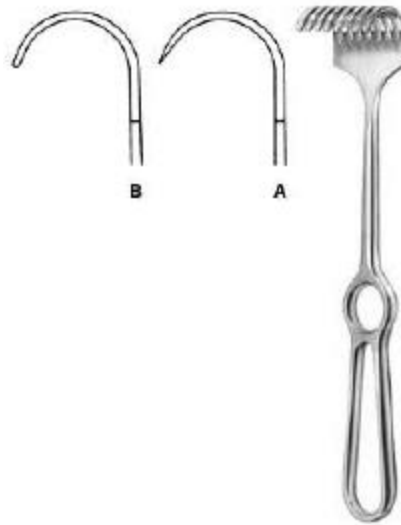

Korte
SST-5-938-08
Retractor
24.5 cm 40 x 30



Israel
SST-5-939-04
Retractor
25.5 cm

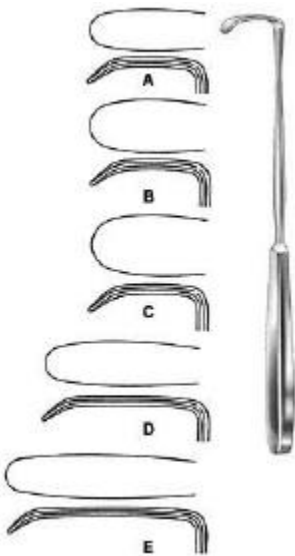

Langenbeck
SST-5-940-01
Retractor

22.5 cm 30 x 11 mm, 22.5 cm 30 x 14 mm,
22.5 cm 30 x 16 mm, 22.5 cm 40 x 11 mm,
22.5 cm 50 x 11 mm



Langenbeck
SST-5-942-21
Retractor
21 cm 65 x 20 mm



Langenbeck
SST-5-943-21
Retractor
22.5 cm 85 x 15 mm

Retractors



Lahey
SST-5-944-19
Retractor
19.5 cm 36 x 19 mm



Little
SST-5-945-20
Retractor
20 cm 13 x 15 mm



Kocher
SST-5-946-18
Retractor
23 cm 43 x 18 mm, 23 cm 53 x 20 mm, 23 cm 63 x 25 mm, 23 cm 77 x 30 mm, 23 cm 78 x 40 mm

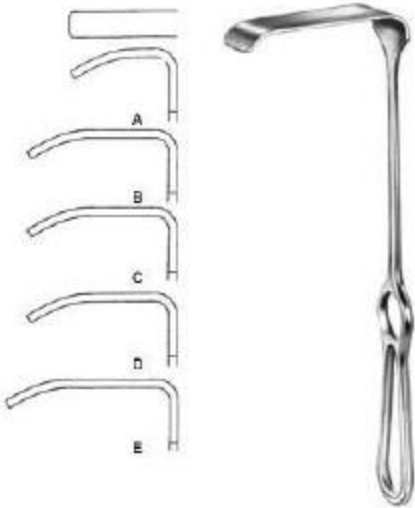

Kocher-Langenbeck
SST-5-947-01
Retractor

21.5 cm 25 x 6 mm, 21.5 cm 35 x 8 mm,
21.5 cm 35 x 11 mm, 21.5 cm 35 x 15 mm,
21.5 cm 40 x 11 mm, 21.5 cm 55 x 11 mm,
21.5 cm 70 x 14 mm, 21.5 cm 80 x 12 mm



Kocher-Langenbeck
SST-5-948-01
Retractor

21.5 cm 25 x 10 mm, 21.5 cm 40 x 13 mm,
21.5 cm 60 x 13 mm, 21.5 cm 40 x 18 mm,
21.5 cm 60 x 18 mm, 21.5 cm 85 x 18 mm,
21.5 cm 60 x 25 mm, 21.5 cm 85 x 25 mm

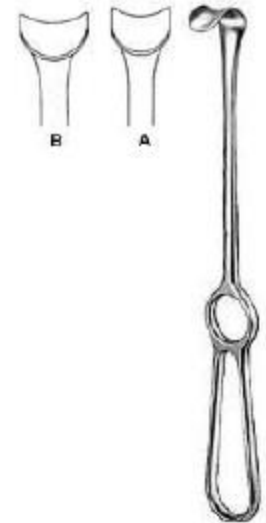

Kocher
SST-5-949-01
Retractor

21.5 cm 22 x 12, 21.5 cm 24 x 14 mm

Retractors

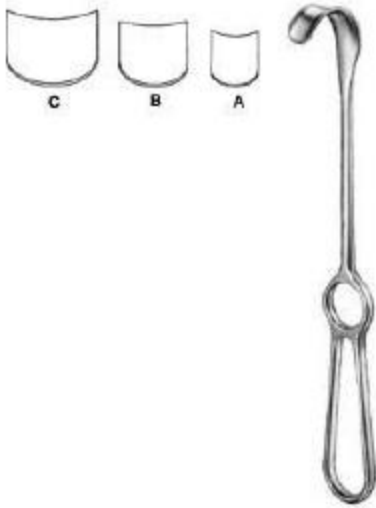

Kocher
SST-5-950-01

Retractor

22 cm 42 x 10 mm, 22 cm 42 x 15 mm, 22 cm 43 x 20 mm

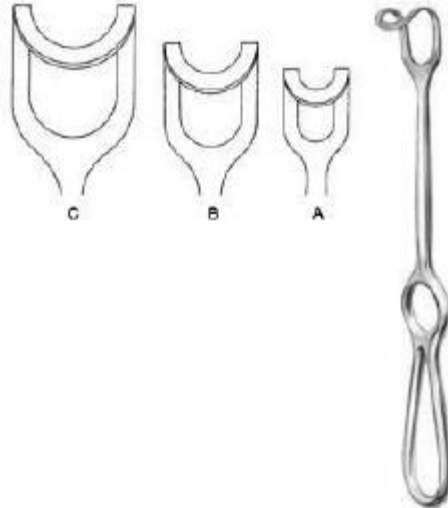

Middeldorpf
SST-5-951-01

Retractor

21.5 cm 18 x 17 mm, 23 cm 25 x 22 mm, 24.5 cm 30 x 31 mm



Doyen-Stille
SST-5-952-01

Retractor

26 cm 97 x 29 mm, 26 cm 101 x 31 mm, 26 cm 127 x 52 mm



Hosel
SST-5-953-01

Retractor

26 cm 63 x 21 mm, 26 cm 83 x 30 mm, 26 cm 103 x 30 mm, 26 cm 120 x 30 mm, 26 cm 140 x 30 mm, 26 cm 140 x 40 mm



Middeldorpf
SST-5-954-01

Retractor

27 cm 48 x 45 mm, 27 cm 52 x 50 mm, 27 cm 60 x 70 mm

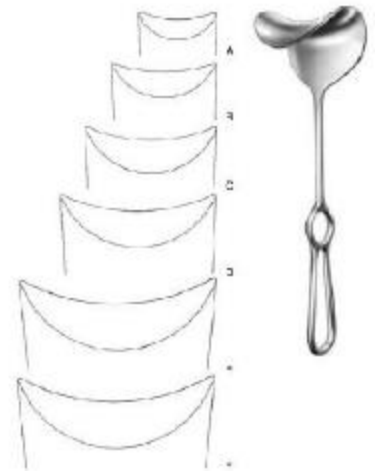

Fritsch
SST-5-955-00

Retractor

23.5 cm 37 x 31 mm, 24 cm 38 x 40 mm, 25 cm 43 x 51 mm, 25 cm 49 x 61 mm, 25.5 cm 48 x 75 mm, 25.5 cm 65 x 85 mm

Retractors



Doyen
SST-5-956-25
Retractor
24 cm 48 x 88 mm



Kocher
SST-5-957-22
Retractor
24 cm 73 x 25 mm



Kocher
SST-5-958-01
Retractor
25 cm 80 x 45 mm, 25 cm 80 x 55 mm, 25 cm 80 x 65 mm



Martin
SST-5-959-25
Retractor
26 cm 110 x 27 mm

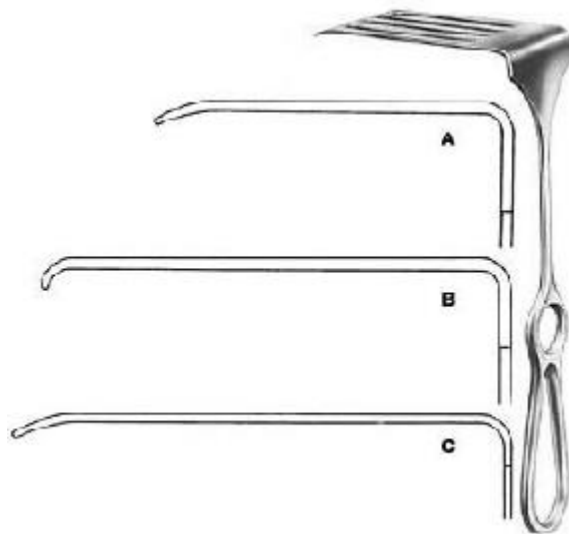

Coryllos
SST-5-960-01
Retractor
24 cm 85 x 22 mm, 24 cm 108 x 43 mm, 24 cm 119 x 65 mm



Davidson
SST-5-961-01
Retractor
19 cm 80 x 54 mm, 18.5 cm 80 x 95 mm

Retractors



Sauerbruch
SST-5-962-25

Retractor
25.5 cm 127 x 38 mm

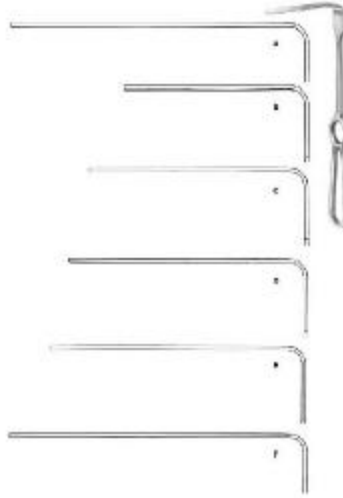

Brunner
SST-5-963-08

Retractor
25.5 cm 84 x 20 mm, 25.5 cm 104 x 25 mm,
25.5 cm 124 x 30 mm, 25.5 cm 130 x 30
mm, 25.5 cm 144 x 30 mm, 25.5 cm 160 x
30 mm, 25.5 cm 164 x 30 mm

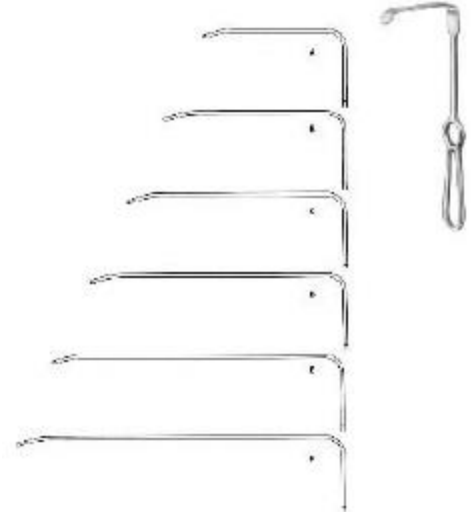

Brunner
SST-5-964-08

Retractor
25.5 cm 82 x 20 mm, 25.5 cm 102 x 20 mm,
25.5 cm 122 x 25 mm, 25.5 cm 140 x 25
mm, 25.5 cm 162 x 30 mm, 25.5 cm 182 x
30 mm

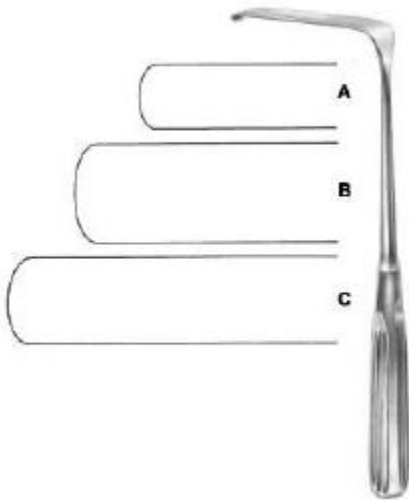

Sauerbruch
SST-5-965-01

Retractor
22.5 cm 50 x 15 mm, 22.5 cm 63 x 23 mm,
22.5 cm 80 x 20 mm



Deaver
SST-5-966-01

Retractor
18 cm 19 mm

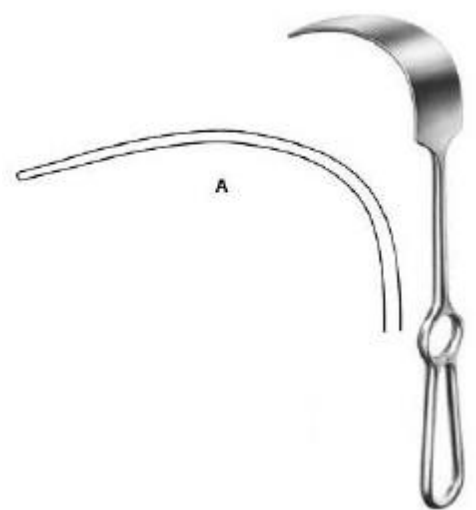

Mikulicz
SST-5-968-01

Retractor
25 cm 90 x 35 mm, 25 cm 125 x 50 mm, 25
cm 160 x 50 mm

Retractors



Mikulicz
SST-5-969-26
Retractor
26 cm 90 x 55 mm

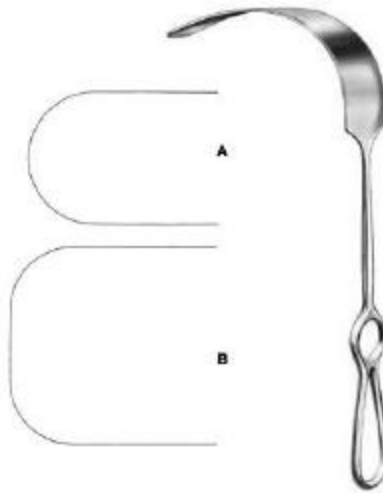

Kelly
SST-5-970-01
Retractor
27.5 cm 205 x 38 mm, 27.5 cm 205 x 57 mm



Farabeuf
SST-5-971-00
Retractor
15 cm Fig. 1 = 23 x 16, 15 cm Fig. 1 = 26 x 16, 15 cm Fig. 2 = 27 x 16, 15 cm Fig. 2 = 30 x 16

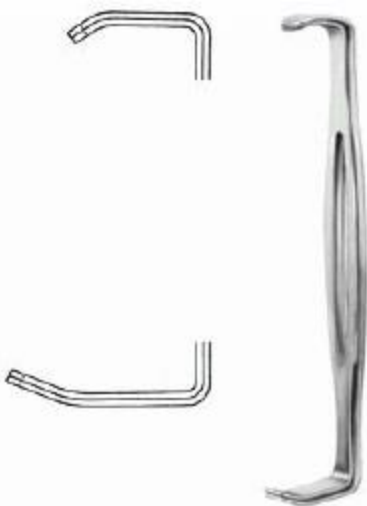

Parker-Langenbeck
SST-5-972-00
Retractor
21.5 cm Fig. 1 = 21x15 mm, 21.5 cm Fig. 1 = 40x15 mm, 21.5 cm Fig. 2 = 25x15 mm, 21.5 cm Fig. 2 = 45x15 mm



Alm
SST-5-973-07
Wound Spreaders, self-retaining
7 cm



Alm
SST-5-974-07
Wound Spreaders, self-retaining
7 cm

Retractors



Gosset
SST-5-975-22

Abdominal Retractor
18.5 cm



Balfour-Baby
SST-5-976-00

Abdominal Retractor spreading 90mm, 1
central blade 24 x 20 mm
12.5 cm



Balfour
SST-5-977-00

Abdominal retractor spreading 180 mm,
lateral blades 70 x 35 mm, 1 central blade
20 cm



Deaver
SST-5-967-04

Retractor

31.5 cm 25 mm, 31.5 cm 38 mm, 31.5 cm
50 mm, 31.5 cm 100 mm

Probes



Probe
SST-5-1001-11

Probe
11.5cm, 13 cm , 14.5 cm , 16 cm, 18 cm,
20cm, 25 cm , 30 cm



Probe
SST-5-1002-11

Probe
11.5 cm, 13 cm , 14.5 cm , 16 cm, 18 cm,
20cm, 25 cm , 30 cm



Probe
SST-5-1003-13

Probe
13 cm , 14.5 cm , 16 cm, 18 cm, 20 cm, 25
cm



Probe With Eye
SST-5-1004-13

Probe with eye
13 cm , 14.5 cm , 16 cm



Myrtle Leaf Probe
SST-5-1006-13

Myrtle Leaf Probe
13 cm , 14.5 cm , 16 cm, 18 cm, 20 cm



Grooved Director
SST-5-1007-13

Grooved Director
13 cm , 14 cm, 16 cm



Grooved Director
SST-5-1008-13
Grooved Director
13 cm , 14.5 cm , 16 cm



Doyen
SST-5-1009-14
Grooved Director
14.5 cm



Nelaton
SST-5-1010-16
Grooved Director
16 cm

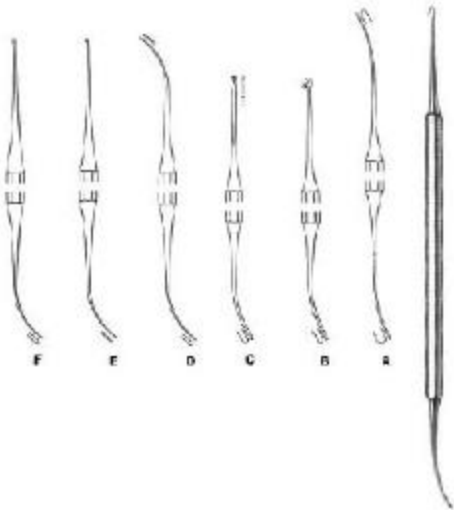

Varady
SST-5-1011-01
Phlebodissector
18 cm, 17.5 cm

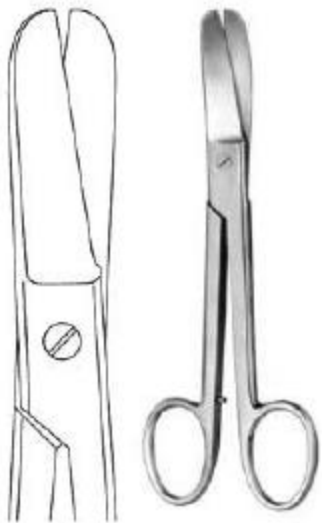

Lorenz
SST-6-101-23
Bandage Scissors heavy pattern
23 cm



Lister
SST-6-102-14
Bandage Scissors
14.5 cm , 18.5 cm , 20 cm



Bergmann
SST-6-103-23
Plaster Shears
23.5 cm



Esmarch
SST-6-104-20
Plaster Shears heavy pattern, short blades
20 cm



Bandage Scissors Black Plastic Ring With Autodavable
SST-6-105-15
Bandage Scissors black plastic ring with autodavable
16 cm, 19 cm



Bandage Scissors Black Plastic Rings
SST-6-106-18
Bandage Scissors black plastic rings
16 cm, 19 cm

Plaster

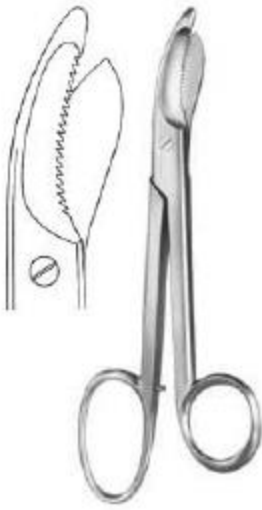

Brun's
SST-6-107-24
Plaster Scissors
24 cm



Stille-Martin
SST-6-108-23
Plaster Shears
23 cm , 27 cm, 38 cm

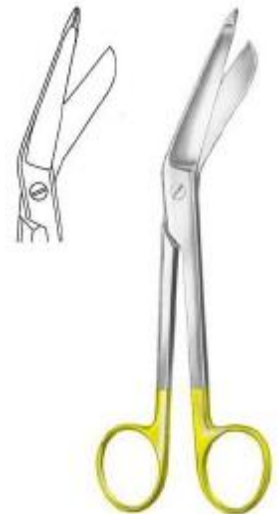

Lister
SST-6-109-18
Bandage Scissors
18 cm

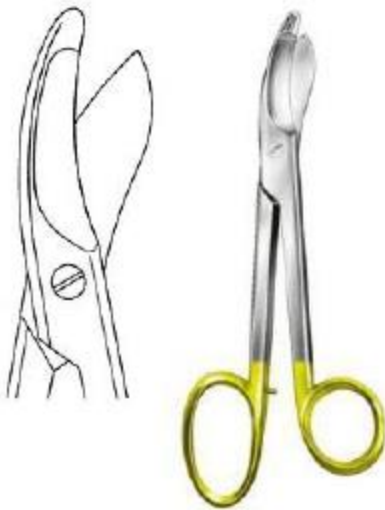

Brun's
SST-6-110-24
Plaster Scissors
24 cm



Hopkins
SST-6-111-20
Plaster Knife with wooden handle
20 cm



Reiner
SST-6-112-18
Plaster Knife
18 cm



Reiner
SST-6-113-18
Plaster Knife
18 cm



Martin
SST-6-114-21
Plaster Knife with wooden handle
21 cm



Engel
SST-6-115-14
Plaster Saw
15.5 cm

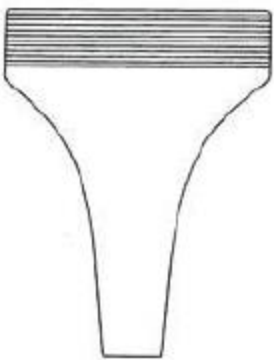

Hennig
SST-6-116-28
Plaster Spreader
28 cm

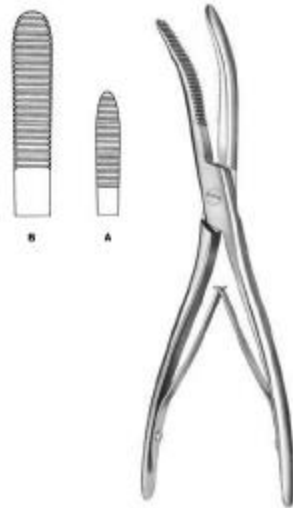

Wolff
SST-6-117-18
Plaster Breaker
18 cm, 26.5 cm



Gigli
SST-8-101-01
Wire Saw Handle



De Martel
SST-8-102-33
Wire Saw Guide
33 cm



Crutchfield
SST-8-103-01
Skull Traction Tong small pattern



Skull Traction Tong Large Pattern
SST-8-104-01
Skull Traction Tong large pattern
22.5 cm



Dahlgren
SST-8-105-20
Cranial Rongeur
20 cm



Olivecrona-Toennis
SST-8-106-14
Clip Applying Forceps



McKenzie
SST-8-107-19
Clip Applying Forceps
18.5 cm



Olivecrona
SST-8-108-18
Dura Dissector
18 cm



Olivecrona
SST-8-109-19
Dura Dissector
20 cm



Milligan
SST-8-110-21
Dura Dissector
21.5 cm



Davis
SST-8-111-21
Dura Dissector sharp
21.5 cm



Dura Dissector
SST-8-112-22
Dura Dissector
22 cm



Davis
SST--8-113-24
Dura Dissector
24.5 cm



Love
SST-8-114-19
Nerve Root Retractor
21.5 cm, 18 cm, 11 cm



Olivecrona
SST-8-115-18
Brain Spatula
18 cm



Scoville
SST-8-116-23
Nerve Root Retractor 8mm
23.5 cm



Holsher
SST-8-117-24
Nerve Root Retractor 8mm
23.5 cm

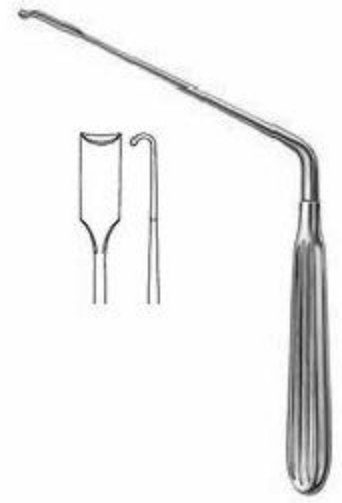

Scoville
SST-8-118-19
Nerve Root Retractor 7mm
16.5 cm



Groningen
SST-8-119-26
Nerve Hook
26.5 cm



Groningen
SST-8-120-26
Nerve Hook
26.5 cm



Cushing
SST-8-121-19
Nerve Hook blunt
19 cm , 28 cm

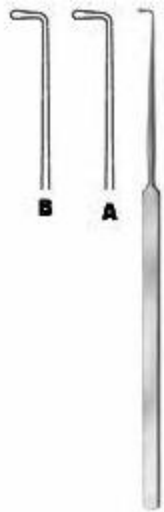

Cushing
SST-8-122-19
Nerve Hook
19.5 cm , 28 cm



Smithwick
SST-8-123-17
Smithwick
17 cm , 21 cm



Halle
SST-8-125-20
Dura Knife
20 cm



Adson
SST-8-126-20
Dura Hook
20 cm



Graham
SST-8-127-16
Dura Hook blunt
16.5 cm



Sachs
SST-8-128-18
Dura Hook sharp
18 cm



Toennis
SST-8-129-15
Dura Hook sharp
14.5 cm



Frazier
SST-8-130-13
Dura Hook sharp
13 cm , 18 cm



Krayenbuhl
SST-8-131-01
Nerve and Vessel Hooklet
18.5 cm Fig. 1 , 18.5 cm Fig. 2



Cloward
SST-8-132-16
Lamina Spreader
16 cm

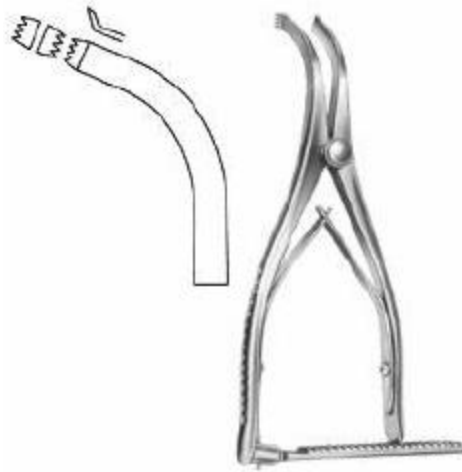

Inge
SST-8-133-17
Lamina Spreader
16 cm



Inge
SST-8-134-27
Lamina Spreader
25.5 cm

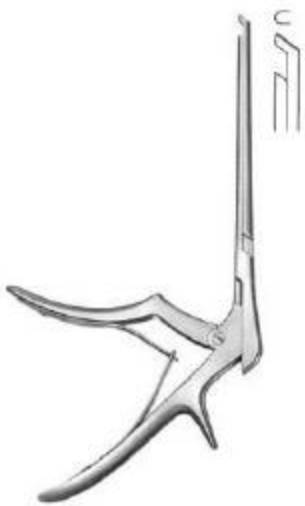

Ferris-Smith Kerrison
SST-8-135-03
Laminectomy Punch 3mm downwards
cutting 40 degree shaft length 180 mm



Ferris-Smith Kerrison
SST-8-138-01
Laminectomy Punch upwards cutting shaft
length 180 mm
1 mm, 2 mm, 3 mm, 4 mm, 5 mm, 6 mm

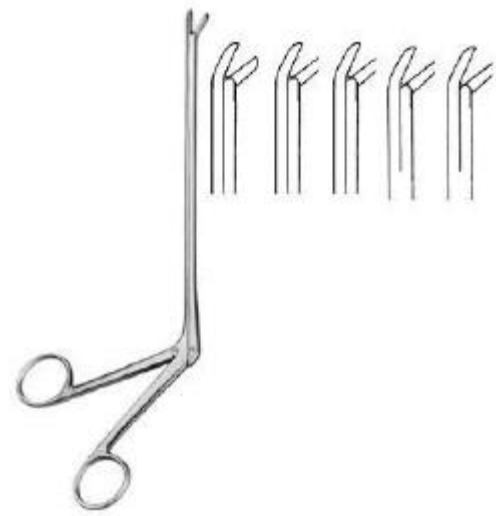

Cushing
SST-8-139-01
Laminectomy Rongeur jaw 2 x 10 to 4 x 10
mm straight shaft length 180 mm

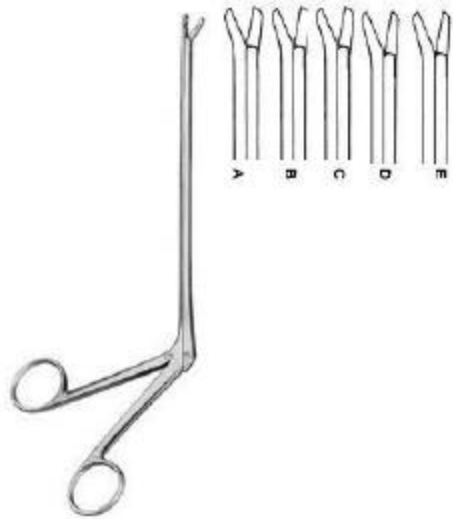

Cushing
SST-8-140-01

Laminectomy Rongeur jaw 2 x 10 to 4 x 10 mm upwards 45
degree shaft length 120 mm



Ferris-Smith Kerrison
SST-8-137-01

Laminectomy Punch
1 mm, 2 mm, 3 mm, 4 mm, 5 mm, 6 mm



Bone Shear
SST-9-101-23
Bone Shear
23 cm



Rib Shear
SST-9-102-22
Rib Shear
23 cm



Gluck
SST-9-103-22
Rib Shears
21 cm



Giertz-Stille
SST-9-104-27
Rib Shear
24.5 cm



LeSSTche
SST-9-105-24
Sternum Chisel
24.5 cm



Rib Retractor
SST-9-106-01
Rib Retractor lateral blades 12 x 16 mm
spreading 95 mm



Finochietto, Infant
SST-9-107-01

Rib Retractor lateral blades 15 x 15 mm
spreading 75 mm
Size 1



Finochietto, Baby
SST-9-108-01

Rib Retractor lateral blades 31 x 31 mm
spreading 100 mm
Size 1



Finochietto
SST-9-109-01

Rib Retractor lateral blades 40 x 45 mm
spreading 135 mm
Size 1



Burford
SST-9-110-01

Rib Retractor with two pairs of blades 47 x 62
mm + 65 x 62 mm, spreading 200 mm
Size 1



Castaneda
SST-9-111-01

Rib Retractor lateral blades 10,5 x 32 mm
spreading 65 mm
Size 1



Finochietto (Modif.)
SST-9-112-01

Rib Retractor lateral blades 14 x 15 mm
spreading 120 mm
Size 1

Cardiovascular



Haight

SST-9-113-90

Rib Retractor lateral blades 30 x 30 mm
spreading 120 mm
Size 1



Morse-Favaloro

SST-9-114-01

Sternal Retractor 4 movable blades 17 x 22
mm spreading 160 mm Sternal Retractor
Size 1



Morse

SST-9-115-00

Sternal Retractor 4 movable blades 22 x 27
mm spreading 200 mm
Size 1



Tuffier

SST-9-116-02

Rib Retractor lateral blades 22 x 27 mm
spreading 200 mm
Size 1



Finochietto, Baby

SST-9-117-75

Rib Retractor lateral blades 14 x 15 mm
spreading 75 mm
Size 1



Finochietto

SST-9-118-01

Rib Retractor lateral blades 30 x 45 mm
spreading 150 mm
Size 1



DeBakey

SST-9-119-00

Rib Retractor spreading 150 mm

Size 1



DeBakey

SST-9-120-00

Rib Retractor spreading 200 mm

Size 1



Thoracic Retractor

SST-9-121-00

Thoracic Retractor

Size 1



Sellors

SST-9-121-00

Rib Contractor

20 cm



Bailey-Baby

SST-9-123-14

Rib Contractor

15.5 cm



Bailey

SST-9-124-16

Rib Contractor

20 cm

Cardiovascular



Bailey-Gibbon
SST-9-125-16
Rib Contractor
20 cm



Allison
SST-9-126-30
Lung Spatula
29.5 cm, 32.5 cm



Price-Thomas
SST-9-127-22
Bronchus Clamp
22 cm



Price-Thomas
SST-9-128-22
Bronchus Clamp
22 cm

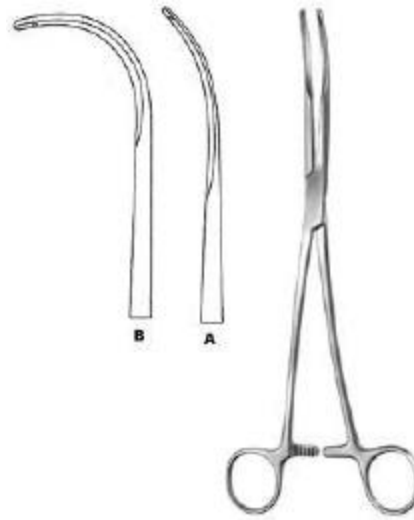

Semb
SST-9-129-24
Bronchus Clamp
24.5 cm



Lovelace
SST-9-130-20
Lung Grasping Forceps
20.5 cm

Cardiovascular



Lovelace
SST-9-131-20
Lung Grasping Forceps
19 cm



DeBakey-Satinsky
SST-9-132-07
Bulldog Clamp
7", 9 cm



Glover
SST-9-133-06
Bulldog Clamp
6 cm



Santulli
SST-9-134-07
Bulldog Clamp
7



Gregory, Soft
SST-9-135-09
Bulldog Clamp
9 cm, 11 cm



Gregory
SST-9-136-01
Bulldog Clamp
10.5 cm

Cardiovascular

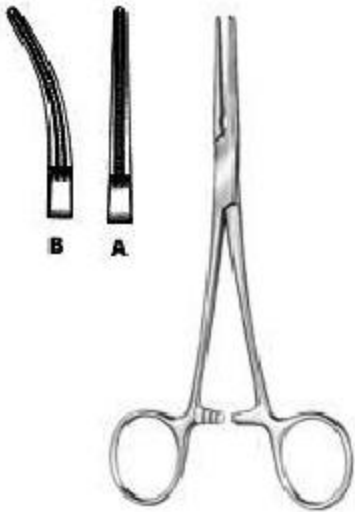

DeBakey-Rankin
SST-9-137-16
Haemostatic Forceps
16 cm



DeBakey-Mosquito
SST-9-138-15
Haemostatic Forceps
15 cm



Ochsner
SST-9-139-23
Aortic Clamp
23.5 cm



Diethrich
SST-9-140-21
Aortic Clamp
22 cm

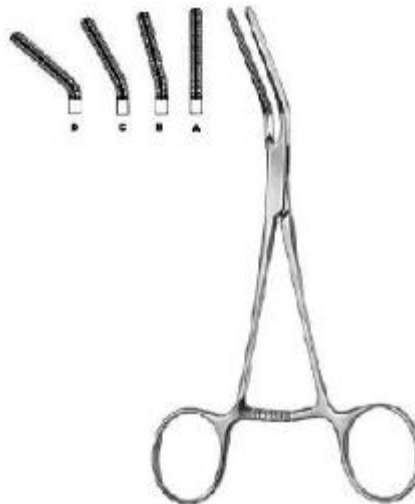

Dardik
SST-9-141-00
Multi purpose Vascular Clamp
15 cm



Dale
SST-9-142-18
Peripheral Vascular Clamp
18 cm

Cardiovascular

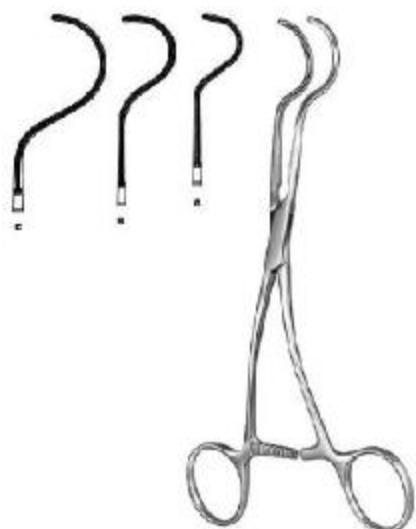

Dale

SST-9-143-17

Peripheral Vascular Clamp
17.5 cm

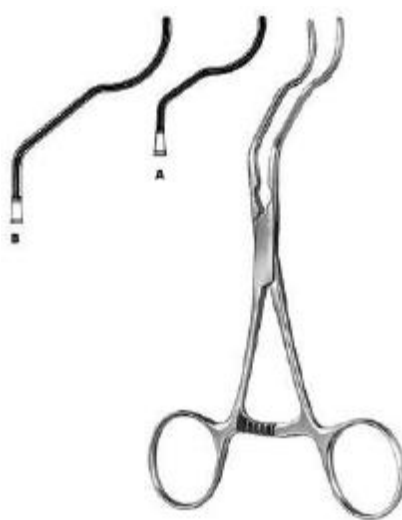

Gregory

SST-9-144-14

Profunda Clamp
13 cm , 16 cm, 18 cm

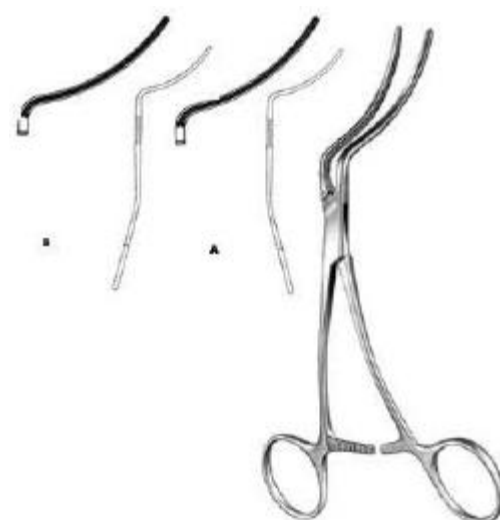

Martin

SST-9-145-16

Peripheral Vascular Clamp
16.5 cm



Husfeldt

SST-9-146-18

Peripheral Vascular Clamp
17.5 cm



Husfeldt

SST-9-147-18

Peripheral Vascular Clamp
18 cm



Husfeldt

SST-9-148-17

Peripheral Vascular Clamp
17 cm

Cardiovascular



DeBakey
SST-9-149-16
Vascular Forceps
16 cm



DeBakey
SST-9-150-16
Vascular Forceps
16 cm



DeBakey
SST-9-151-16
Vascular Forceps
16 cm



DeBakey
SST-9-152-16
Vascular Forceps
16 cm



DeBakey
SST-9-153-16
Vascular Forceps
16 cm



DeBakey
SST-9-154-07
Bulldog Clamp
7

Cardiovascular



DeBakey
SST-9-155-07
Bulldog Clamp
7



Applying Forceps
SST-9-156-23
Applying Forceps
23.5 cm



Glover
SST-9-157-06
Bulldog Clamp
7



Glover
SST-9-158-06
Bulldog Clamp
6.5 cm

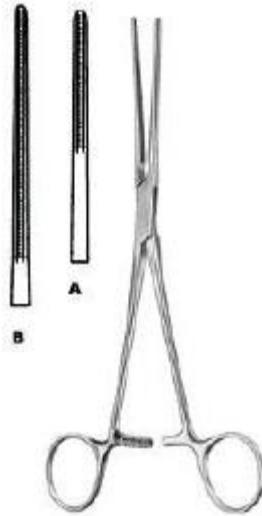

Potts
SST-9-159-21
Coarctation Clamp
21 cm

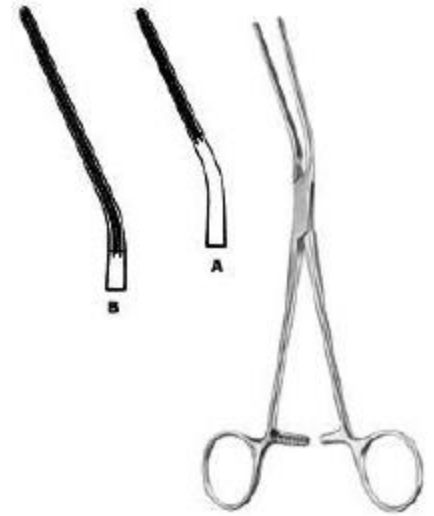

Potts
SST-9-160-21
Coarctation Clamp
20.5 cm

Cardiovascular

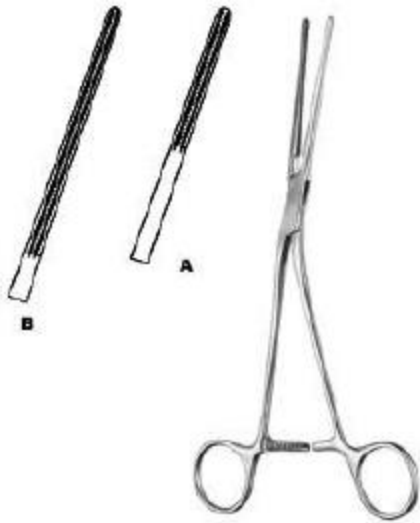

Potts
SST-9-161-21
Coarctation Clamp
20.5 cm



Potts
SST-9-162-22
Anastomosis Clamp
21.5 cm



Potts
SST-9-163-22
Anastomosis Clamp
22 cm



DeBakey
SST-9-164-19
Ligature Forceps
19 cm



DeBakey
SST-9-165-16
Peripheral Vascular Clamp
16 cm



DeBakey
SST-9-166-19
Peripheral Vascular Clamp
16 cm

Cardiovascular

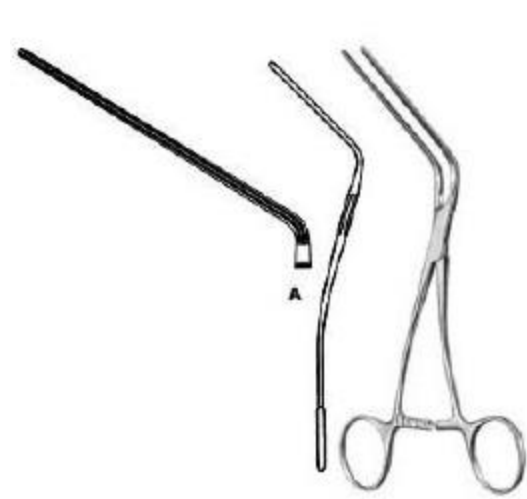

Leland-Jones
SST-9-167-18
Peripheral Vascular Clamp
18 cm



Bainbridge
SST-9-168-15
Multi purpose Vascular Clamp
15 cm



Bainbridge
SST-9-169-15
Multi purpose Vascular Clamp
15 cm

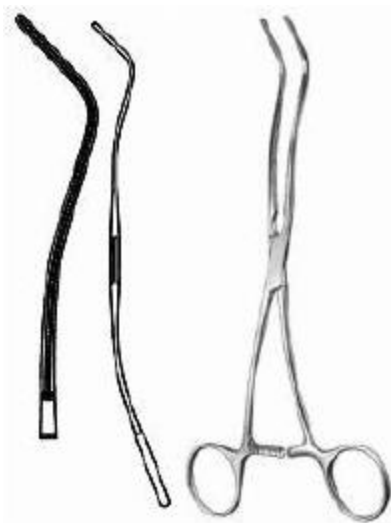

DeBakey
SST-9-170-20
Multi purpose Vascular Clamp
20 cm



DeBakey
SST-9-171-26
Aortic Aneurysm Clamp
26 cm



DeBakey
SST-9-172-28
Aortic Aneurysm Clamp
28 cm

Cardiovascular



DeBakey
SST-9-173-30
Aortic Aneurysm Clamp
30 cm



DeBakey
SST-9-174-27
Aortic Clamp
27 cm



DeBakey
SST-9-175-24
Ligature Forceps
24.5 cm



DeBakey
SST-9-176-24
Ligature Forceps
24.5 cm



DeBakey
SST-9-178-25
Ligature Forceps
27 cm



Weber
SST-9-179-01
Aortic Clamp
24 cm

Cardiovascular



Satinsky
SST-9-180-20
Tangential Occlusion Clamp
22 cm



Harken
SST-9-181-01
Auricle Clamp
24.5 cm



Lees
SST-9-182-23
Bronchus Clamp
23 cm



Lees
SST-9-183-25
Bronchus Clamp
25 cm



Lambert-Kay
SST-9-184-21
Anastomosis Clamp
22.5 cm



DeBakey
SST-9-185-17
Anastomosis Clamp
16.5 cm

Cardiovascular



Morris-DeBakey
SST-9-186-18
Aortic Clamp
16.5 cm



DeBakey-Bahnson
SST-9-187-23
Aneurysm Clamp
23.5 cm

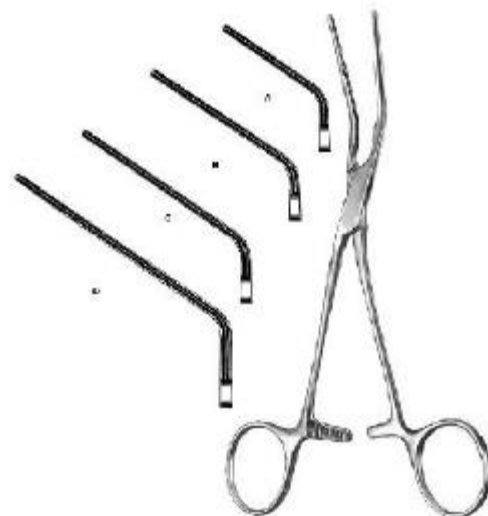

DeBakey
SST-9-188-20
Multi purpose Vascular Clamp
18 cm

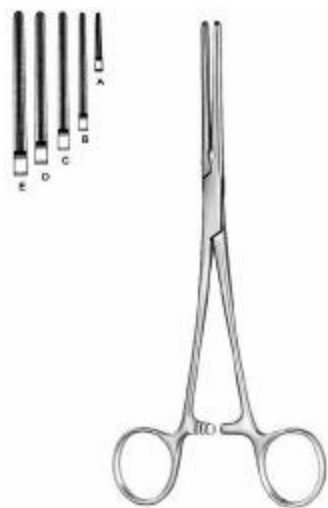

DeBakey-Mosquito
SST-9-189-12
Haemostatic Forceps
12.5 cm



DeBakey-Mosquito
SST-9-190-12
Haemostatic Forceps
12.5 cm



DeBakey
SST-9-191-17
Multi purpose Vascular Clamp
17 cm

Cardiovascular



DeBakey
SST-9-192-16
Multi purpose Vascular Clamp
16.5 cm

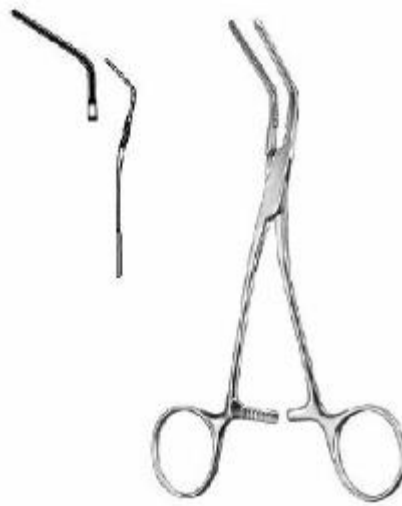

DeBakey
SST-9-193-15
Multi purpose Vascular Clamp
16 cm



DeBakey
SST-9-194-15
Multi purpose Vascular Clamp
16.5 cm



DeBakey
SST-9-195-17
Multi purpose Vascular Clamp
16.5 cm



Glover
SST-9-196-17
Multi purpose Vascular Clamp
17 cm



Glover
SST-9-197-17
Multi purpose Vascular Clamp
17.5 cm

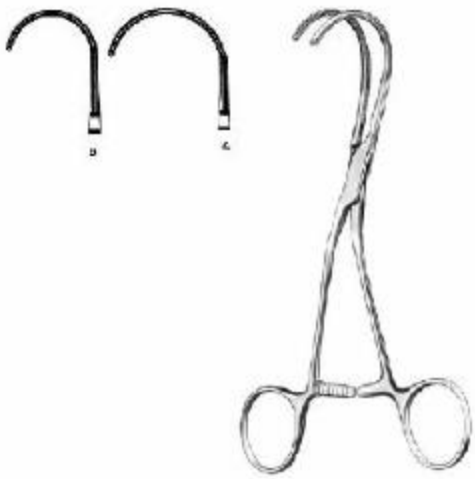

DeBakey
SST-9-198-16
Multi purpose Vascular Clamp
16.5 cm

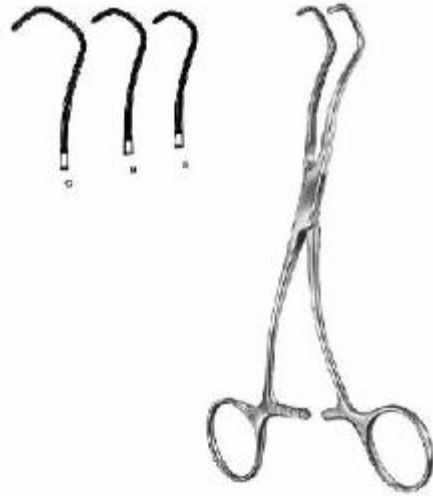

Derra
SST-9-199-16
Anastomosis Clamp
16 cm Fig. 1, 17.5 cm Fig. 3, 18.5 cm Fig. 3



DeBakey-Beck
SST-9-200-17
Anastomosis Clamp
17 cm



Cooley
SST-9-201-16
Vascular Forceps
16 cm

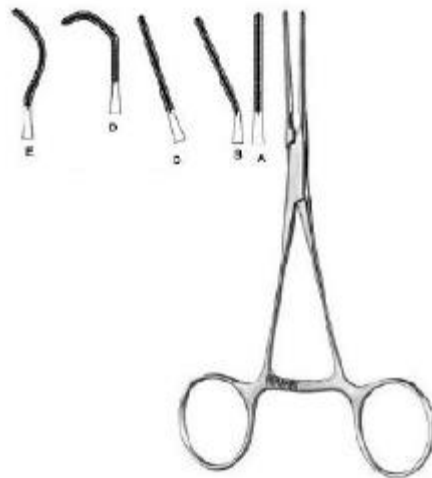

Cooley
SST-9-202-01
Pediatric Vascular Clamp
14.5 cm



Cooley
SST-9-203-21
Iliac Clamp
22 cm

Cardiovascular



Cooley
SST-9-204-17
Anastomosis Clamp
17 cm

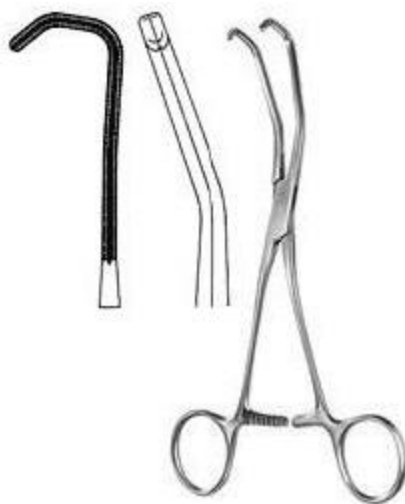

Cooley
SST-9-205-17
Anastomosis Clamp
20 cm



Cooley
SST-9-206-16
Anastomosis Clamp
17 cm



Cooley
SST-9-207-15
Multi purpose Vascular Clamp
16 cm



Cooley
SST-9-208-17
Multi purpose Vascular Clamp
17 cm



Cooley
SST-9-209-17
Multi purpose Vascular Clamp
17 cm

Cardiovascular



Cooley
 SST-9-210-17
 Multi purpose Vascular Clamp
 17.5 cm



Cooley
 SST-9-211-16
 Multi purpose Vascular Clamp
 16.5 cm



Cooley-Derra
 SST-9-212-16
 Anastomosis Clamp
 16.5 cm



Cooley-Beck
 SST-9-213-17
 Anastomosis Clamp
 17 cm

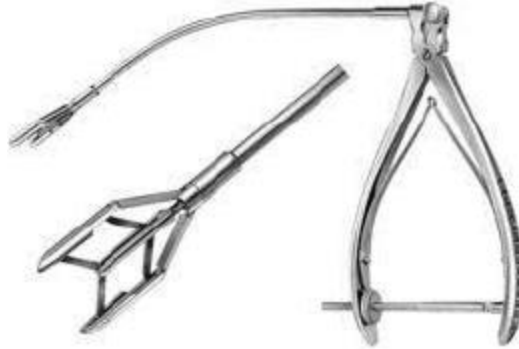

Cooley
 SST-9-214-00
 Aortic Dilator



Cooley
 SST-9-215-05
 Vascular Dilator
 14 cm / 5 ? 11

Cardiovascular



DeBakey
SST-9-216-05
Vascular Dilator
19 cm



Martin
SST-9-217-00
Tunneling Set complete set with three shafts, two handles and 12 tips in storage case.



Hach
SST-9-218-01
Fasciotomy Knife with plastic handle
30 cm



Intima Spatula
SST-9-219-18
Intima Spatula
18.5 cm

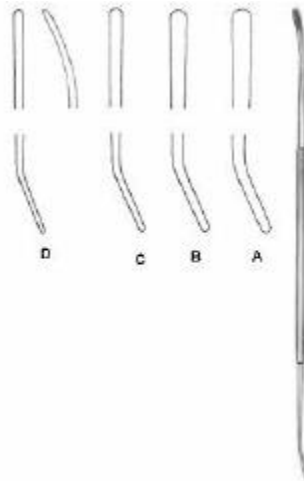

Robb
SST-9-220-01
Vascular Dissector
24 cm Fig. 1 2,5 mm ? , 24 cm Fig. 2 2,0 mm ?



Crile
SST-9-221-20
Nerve Hooklet
20 cm

Cardiovascular

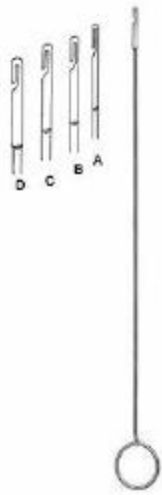

Ligature Catcher
 SST-9-222-15
 Ligature Catcher
 26 cm 1,5 mm



Subramanian-Miniature
 SST-9-223-15
 Aortic Clamp 135 degree
 15.5 cm

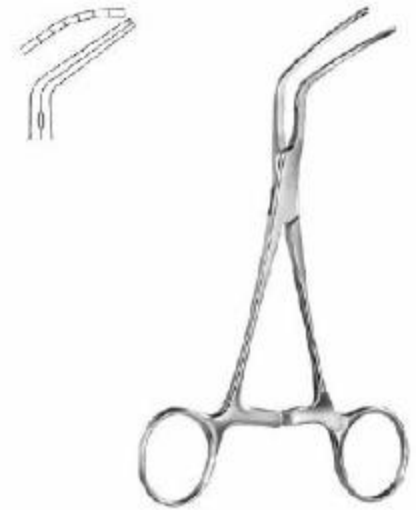

Subramanian
 SST-9-224-16
 Aortic Clamp
 16 cm

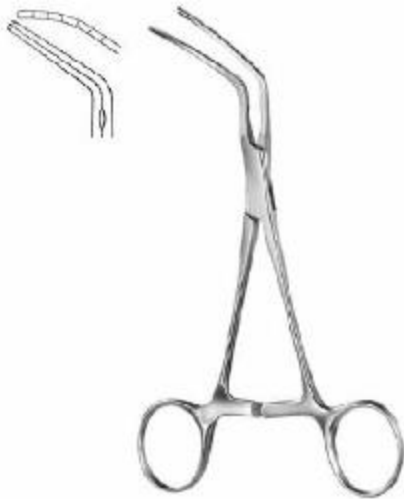

Subramanian
 SST-9-225-16
 Aortic Clamp

14 cm Fig. 1 , 14 cm Fig. 2 , 14 cm Fig. 3

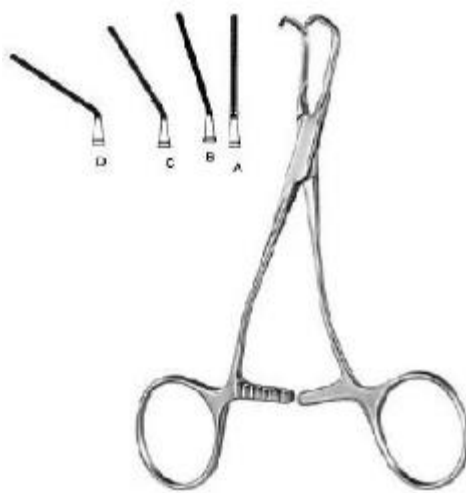

Pediatric Vascular Clamp
 SST-9-226-01
 Pediatric Vascular Clamp



Pediatric Vascular Clamp
 SST-9-227-16
 Pediatric Vascular Clamp
 16.5 cm



Pediatric Vascular Clamp

SST-9-228-16

Pediatric Vascular Clamp

16 cm



Barraquer (Colibri)
SST-11-101-03
Barraquer
Size 1



Bowman
SST-11-102-07
Bowman
Size 1



Critchett
SST-11-103-06
Critchett
Size 1

Tracheotomy

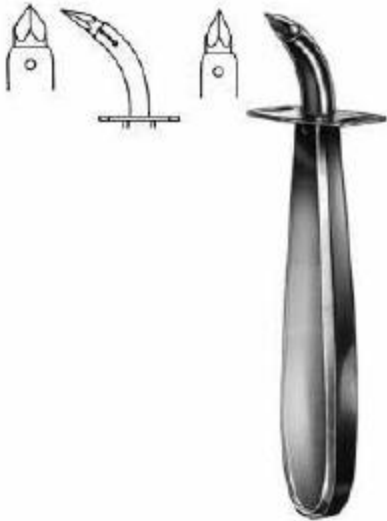

Ueckermann
SST-16-101-13
Tracheotomy Trocar
11.5 cm



Iterson
SST-16-102-16
Tracheal Hook
17 cm



Rose
SST-16-103-13
Tracheal Hook
13.5 cm



Luer
SST-16-104-11
Tracheal Hook
11 cm



Tracheal Hook
SST-16-105-15
Tracheal Hook
15 cm



Lukens
SST-16-106-17
Thymus Retractor
17.5 cm

Tracheotomy



Jackson
SST-16-107-17
Tracheal Hook
18 cm



Kocher
SST-16-108-15
Goitre Enucleator
16.5 cm



Kocher
SST-16-109-15
Goitre Enucleator
16.5 cm



Hofmeister
SST-16-110-21
Goitre Enucleator
20.5 cm



Lahey
SST-16-111-15
Goitre Grasping Forceps
15.5 cm



Luer
SST-16-112-04
Tracheal Tube

Tracheotomy



Luer
SST-6-113-08
Tracheal Tube



Chevalier-Jackson
SST-16-114-04
Tracheal Tube outer tube closed inner tube
closed silver



Speaking Tube
SST-16-115-08
Speaking Tube



Moncorps
SST-17-101-14
Milium Knife
14 cm



Moncorps
SST-17-102-00
Spare Blade



Vidal
SST-17-103-14
Lupus Scraper
13 cm



Wolff
SST-17-105-01
Lupus Curette
14 cm



Kilner
SST-17-106-15
Skin Hooklet
14.5 cm



Gillies
SST-17-107-18
Skin Hooklet
18 cm



Kaye
SST-17-108-03
Face-lift Hook
13 cm

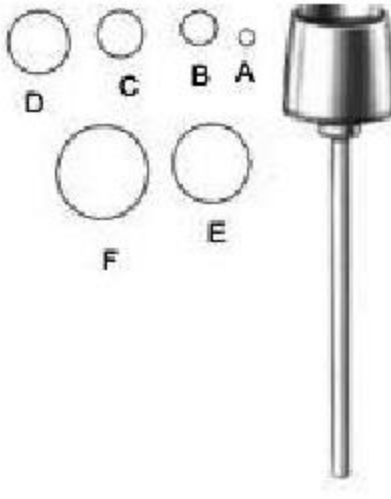

Dermal Punch
SST-17-109-02
Dermal Punch
5.5 cm



Handle
SST-17-110-00
Handle
8 cm

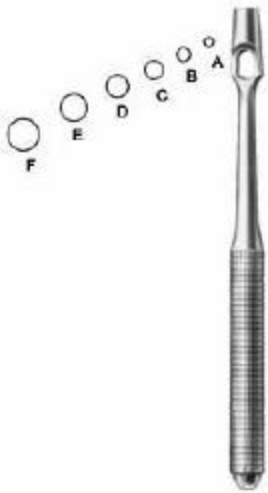

Keyes
SST-17-111-02
Dermal Punch
11 cm



Unna
SST-17-113-14
Comedone Extractor
14.5 cm



Saalfeld
SST-17-114-10
Comedone Extractor
11 cm



Saalfeld
SST-17-115-14
Saalfeld Comedone Extractor
14.5 cm



Schamberg
SST-17-116-10
Comedone Extractor
9.5 cm



Katsch
SST-17-117-14
Comedone Extractor
16 cm



Unna-Vidal
SST-17-118-11
Comedone Extractor
11.5 cm



D'Assump?
SST-17-119-15
Face-lift Forceps
18 cm



Gregory
SST-17-120-14
Face-lift Scissors
14 cm



Kaye
SST-17-121-15
Face-lift Scissors
15 cm, 18 cm



Stella-S
SST-17-122-18
Face-lift Scissors
18 cm



Gorney
SST-17-123-18
Face-lift Scissors
18 cm

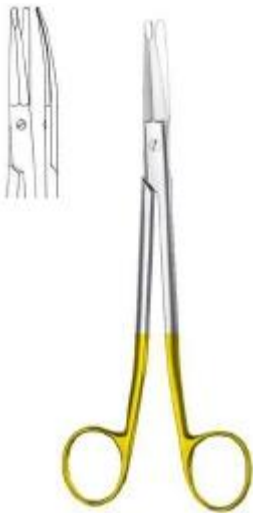

Freeman-Kaye
SST-17-124-18
Face-lift Scissors
18 cm

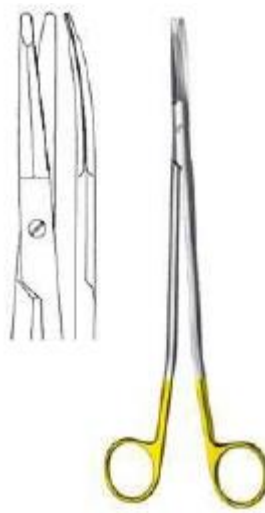

Freeman
SST-17-125-00
Face-lift Scissors
23 cm



Fox
SST-17-104-01
Lupus Curette
14 cm



Unna
SST-17-112-14
Comedone Extractor
14.5 cm

Intestines & Stomach



Allis-Baby

SST-18-101-12

Intestinal and Tissue Grasping Forceps
13 cm

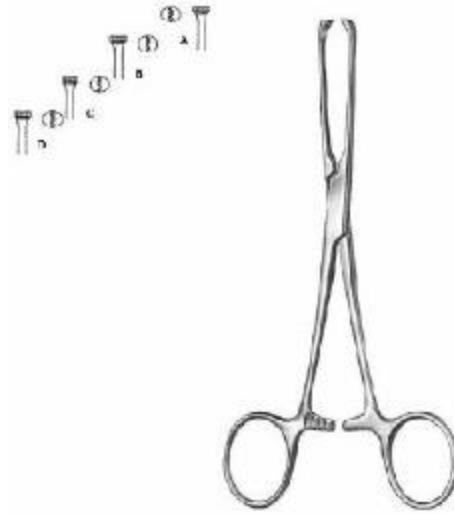

Allis

SST-18-102-15

Intestinal and Tissue Grasping Forceps
15.5 cm, 19 cm, 25.5 cm



Allis

SST-18-103-16

Intestinal and Tissue Grasping Forceps
15.5 cm, 20 cm, 24.5 cm, 30 cm



Allis-Adair

SST-18-104-15

Intestinal and Tissue Grasping Forceps
16 cm



Boys-Allis

SST-18-105-15

Intestinal and Tissue Grasping Forceps
15.5 cm



Thoms-Allis

SST-18-106-20

Intestinal and Tissue Grasping Forceps
20.5 cm

Intestines & Stomach



Allis

SST-18-107-20

Intestinal and Tissue Grasping Forceps
20 cm



Lockwood

SST-18-108-20

Intestinal and Tissue Grasping Forceps
20 cm



Williams

SST-18-109-16

Intestinal and Tissue Grasping Forceps
16.5 cm

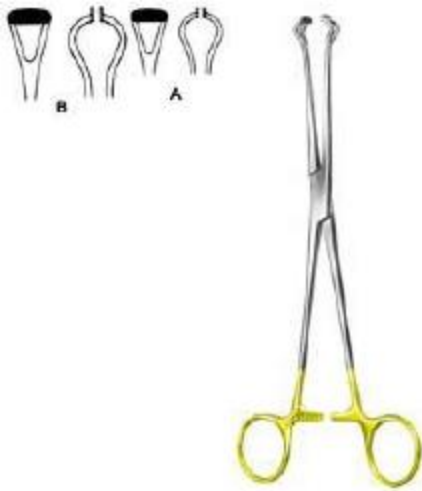

Babcock

SST-18-110-16

Intestinal and Tissue Grasping Forceps
16.5 cm, 21 cm



Babcock

SST-18-111-16

Intestinal and Tissue Grasping Forceps
15.5 cm, 17.5 cm, 21 cm, 24 cm



Babcock

SST-18-112-16

Intestinal and Tissue Grasping Forceps
16.5 cm, 25.5 cm

Intestines & Stomach



Duval

SST-18-113-20

Intestinal and Tissue Grasping Forceps
20.5 cm

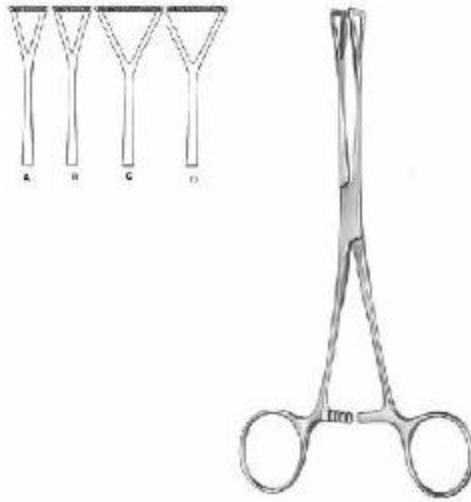

Duval

SST-18-114-18

Intestinal and Tissue Grasping Forceps
18 cm, 25.5 cm, 23 cm

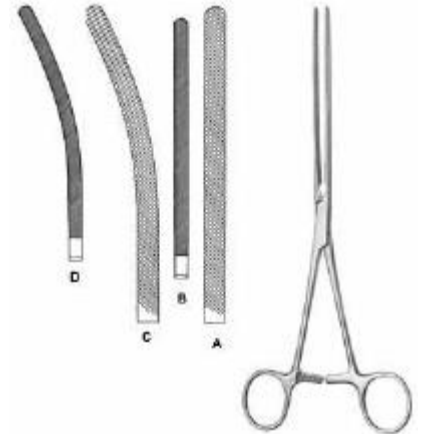

Doyen

SST-18-115-21

Intestinal Clamp
21.5 cm, 23.5 cm



Doyen-Baby

SST-18-116-18

Intestinal Clamp
18 cm, 17.5 cm



Mayo-RoSSTon

SST-18-117-21

Intestinal Clamp
21.5 cm, 23.5 cm, 23 cm

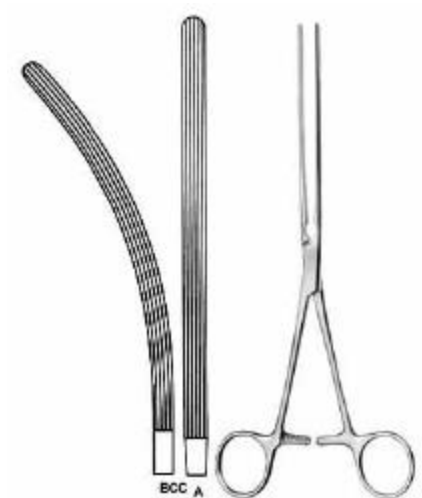

Mayo-RoSSTon

SST-18-118-25

Intestinal Clamp
25.5 cm, 24.5 cm

Intestines & Stomach

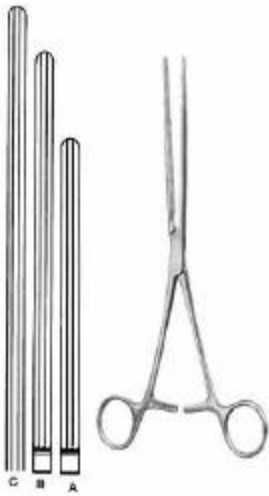

Kocher

SST-18-119-22

Intestinal Clamp

22.5 cm, 25 cm, 28.5 cm

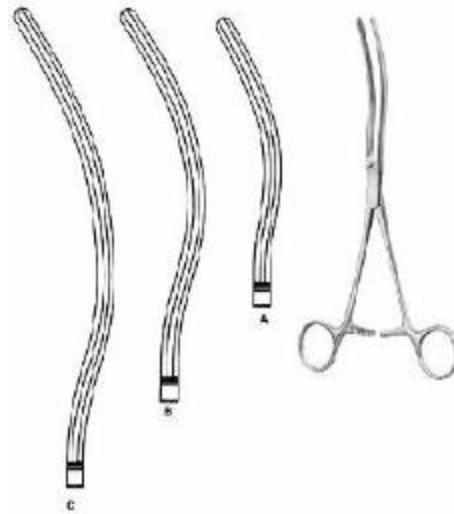

Kocher

SST-18-120-22

Intestinal Clamp

22 cm, 24.5 cm, 27.5 cm



Allen

SST-18-121-16

Intestinal Clamp

16 cm



Payr-Baby

SST-18-122-15

Intestinal and Pylorus Clamp

15 cm

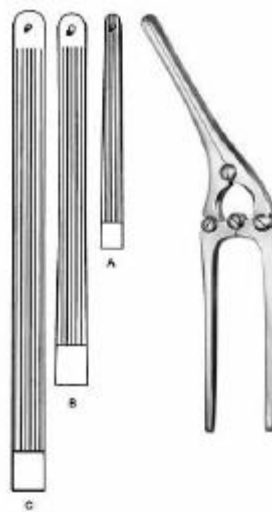

Payr

SST-18-123-21

Intestinal and Pylorus Clamp

20.5 cm, 29 cm, 34.5 cm



Stone-Watt

SST-18-124-07

Intestinal Anastomosis Clamp

8.5 cm, 10 cm

Intestines & Stomach



Stone-Watt
SST-18-125-15
Closing Forceps

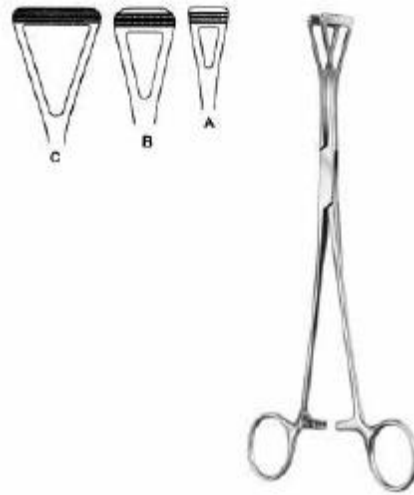

Scheibe
SST-18-126-18
Organ Grasping Forceps
18 cm



Doyen-Baby
SST-18-127-13
Intestinal Clamp
14 cm, 17 cm

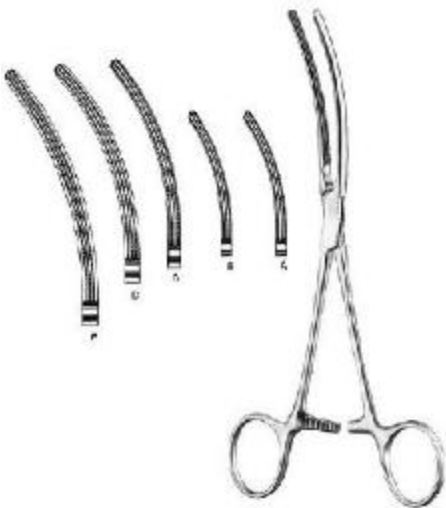

Doyen-Baby
SST-18-128-13
Intestinal Clamp
13.5 cm, 17 cm



Mayo-RoSSon
SST-18-129-25
Intestinal Clamp
26 cm



Mayo-RoSSon
SST-18-130-25
Intestinal Clamp
25 cm

Intestines & Stomach



Kocher
SST-18-131-22
Intestinal Clamp
22.5 cm, 28 cm



Kocher
SST-18-132-22
Intestinal Clamp
22 cm, 25 cm, 27.5 cm



Scudder
SST-18-133-33
Intestinal Clamp
33.5 cm

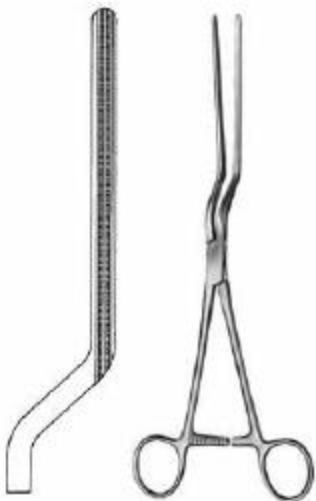

Brunner
SST-18-134-24
Sigmoid Anastomosis Forceps
27 cm



Hayes
SST-18-135-26
Sigmoid Anastomosis Forceps
27 cm, 28 cm



Veidenheimer
SST-18-136-23
Sigmoid Anastomosis Forceps
25 cm

Intestines & Stomach



Fehland
SST-18-137-24
Sigmoid Anastomosis Forceps
24 cm



Resano
SST-18-138-30
Sigmoid Anastomosis Forceps
28 cm



Sims
SST-18-139-15
Rectal Speculum
15.5 cm



Sims
SST-18-140-15
Rectal Speculum
15.5 cm



Mathieu
SST-18-141-19
Rectal Speculum
19 cm



Alan-Parks
SST-18-142-00
Alan-Parks
14 cm

Intestines & Stomach

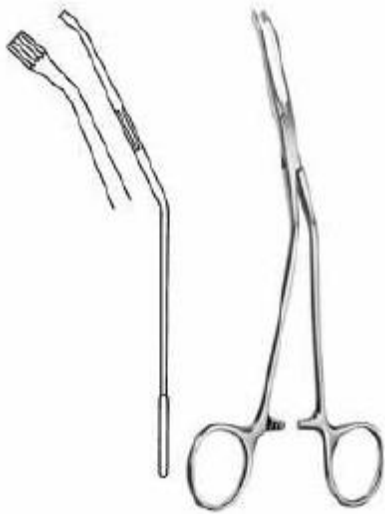

McGinvey
SST-18-143-19
Hemorrhoidal Grasping Forceps
19 cm



Handle For Biopsy Forceps
SST-18-144-00
Handle for biopsy forceps



Rectal Biopsy Forceps
SST-18-145-38
Rectal Biopsy Forceps

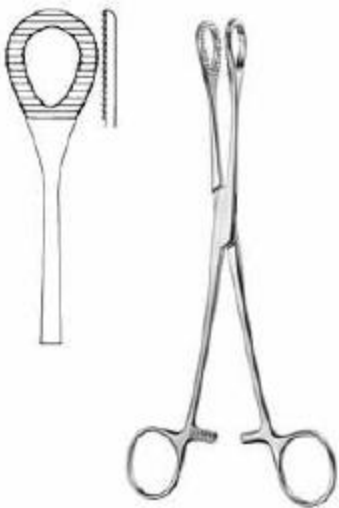

Heywood-Smith
SST-18-146-21
Polypus Grasping Forceps
21 cm

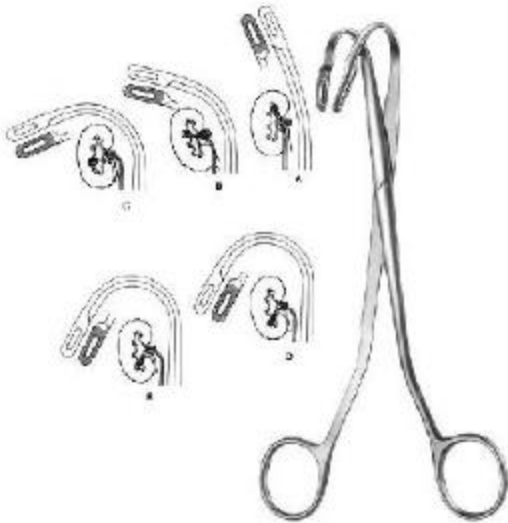

Randall

SST-19-101-23 A

Kidney Stone Forceps

23 cm Fig. 1 , 21 cm Fig. 2, 21 cm Fig. 3



Randall

SST-19-102-23 A

Kidney Stone Forceps

23 cm , 24.5 cm

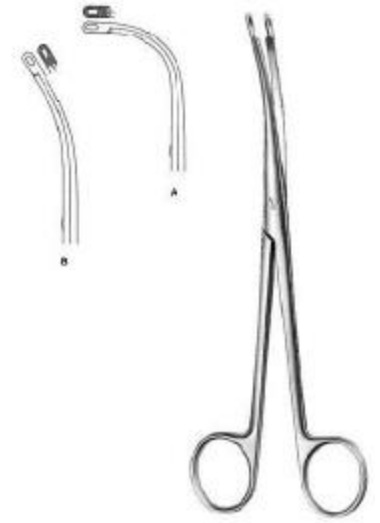

Heiming

SST-19-103-16 A

Kidney Stone Forceps

16 cm Fig. 1, 17 cm Fig. 2

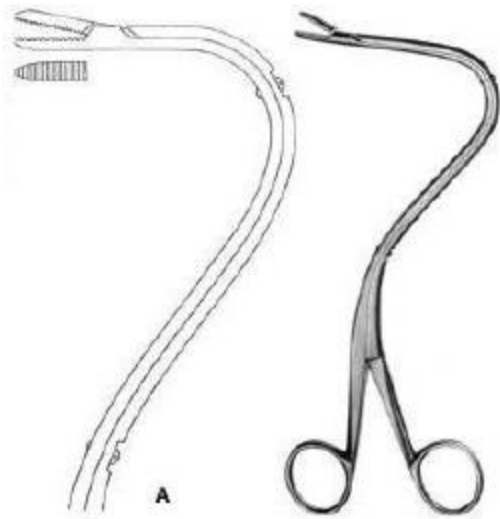

Elsasser

SST-19-104-01 A

Nephrostomy Forceps

21 cm Fig. 1 , 21 cm Fig. 2



Bakes

SST-19-105-01 A

Gall Duct Dilator

32 cm

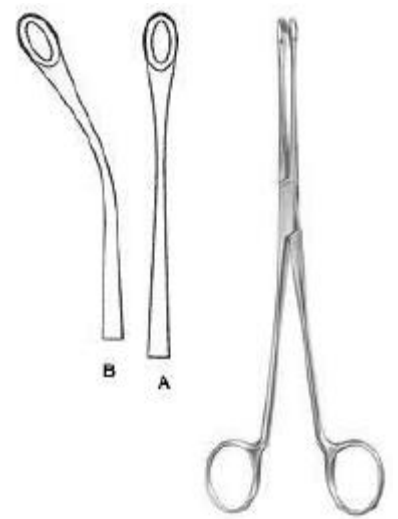

Blake

SST-19-106-20 A

Gall Stone Forceps

21 cm



Mayo-Blake
SST-19-107-20
Gall Stone Forceps
21 cm



Mayo-Blake
SST-19-108-20
Gall Stone Forceps
21 cm



Mixer
SST-19-109-22
Gall Stone Forceps
21.5 cm



Desjardins
SST-19-110-23 A
Gall Stone Forceps
23 cm

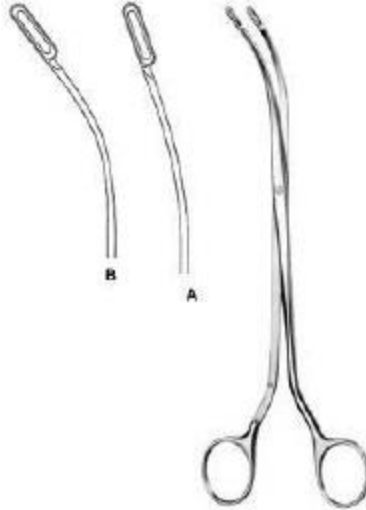

Desjardins
SST-19-111-24 A
Gall Stone Forceps



Luer-Korte
SST-19-112-01 A
Gall Stone Scoop
32 cm Fig. 0 , 32 cm Fig. 00 , 32 cm Fig. 000 , 32 cm Fig. 1, 32 cm Fig. 2, 32 cm Fig. 3, 32 cm Fig. 4

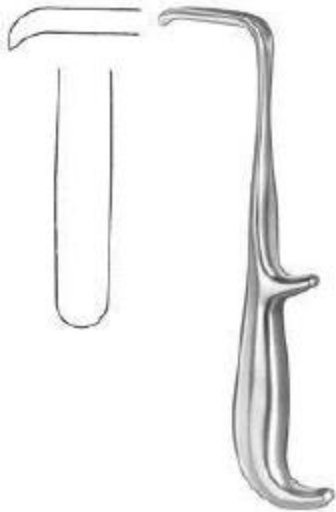

Young
SST-19-113-21
Prostatic Retractor
21.5 cm



Young
SST-19-114-22
Prostatic Retractor
20.5 cm



Young
SST-19-115-21
Prostatic Retractor
22 cm



Young
SST-19-116-22
Prostatic Retractor
21.5 cm



Millin
SST-19-117-24
Capsule Forceps
24.5 cm



Millin
SST-19-118-24
Capsule Forceps
22 cm

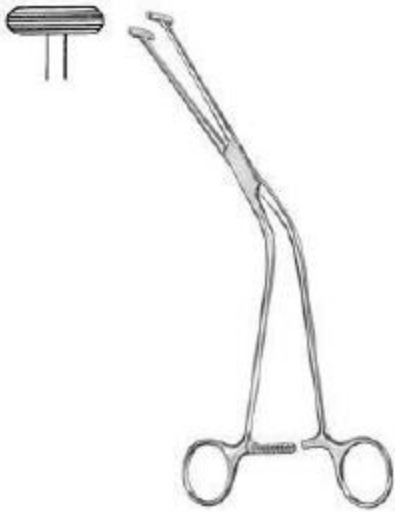

Millin
SST-19-119-23
Capsule Forceps
24.5 cm

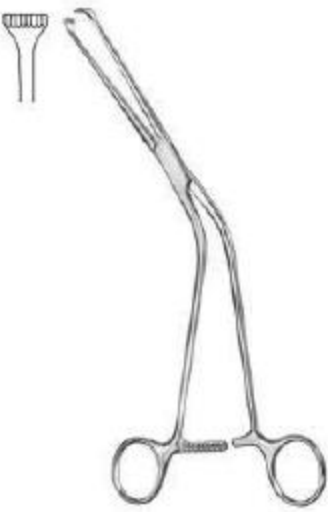

Millin
SST-19-120-23
Capsule Forceps
22 cm

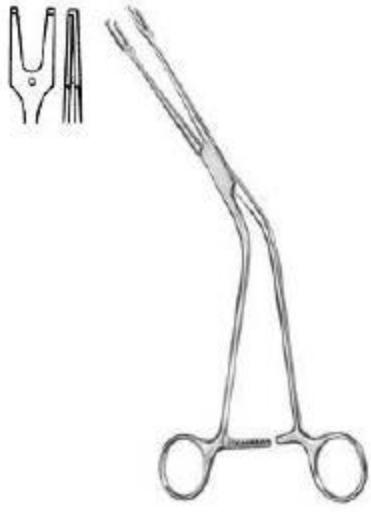

Millin
SST-19-121-24
Ligature Carrying Forceps
24.5 cm



Millin
SST-19-122-00
Bladder Neck Spreader
29



Thomson-Walker
SST-19-123-00
Bladder Retractor



Judd-Masson
SST-19-124-00
Bladder Retractor



Millin
SST-19-125-00 A
Bladder Retractor



Legueu
SST-19-126-27
Bladder Spatula
24 cm , 35 mm

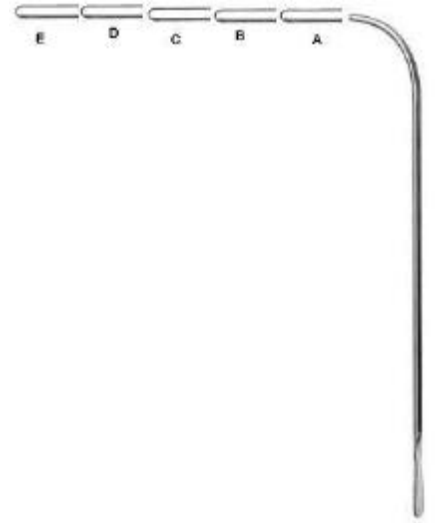

Van Buren
SST-19-127-00 A
Urethral Sound
27.5 cm

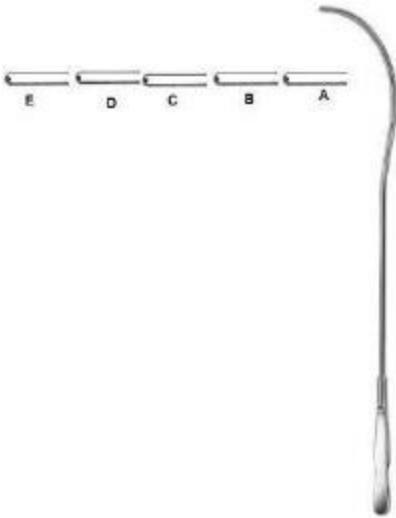

Guyon
SST-19-128-10 A
Urethral Sound
26 cm



Cusco
SST-20-101
Vaginal Speculum
75 x 32 mm, 85 x 35 mm



Cusco
SST-20-102-01
Vaginal Speculum
75 x 18 mm



Cusco
SST-20-103-01
Vaginal Speculum
80 x 22 mm, 100 x 25 mm , 105 x 27 mm



Cusco
SST-20-104-01
Vaginal Speculum
75 x 34 mm , 85 x 37 mm



Collin
SST-20-105-01
Vaginal Speculum
85 x 30 mm , 100 x 35 mm



Pederson
SST-20-106-01
Vaginal Speculum
75 x 13 mm, 100 x 22 mm



Grave
SST-20-107-01
Vaginal Speculum
75 x 20 mm, 95 x 35 mm



Semm
SST-20-108-01
Vaginal Speculum
100 x 20 mm, 105 x 27 mm



Sims
SST-20-109-01
Vaginal Speculum
65 x 25 mm, 70 x 30 mm



Kristeller
SST-20-110-01
Vaginal Speculum
70 x 27 mm



Kristeller
SST-20-111-01
Vaginal Retractor
75 x 23 mm



Kristeller
SST-20-112-01
Vaginal Speculum
Size 1



Kristeller
SST-20-113-01
Vaginal Speculum
105 x 18 mm



Kristeller
SST-20-114-01
Vaginal Retractor
110 x 14 mm



Kristeller
SST-20-115-01
Vaginal Speculum
Size 1

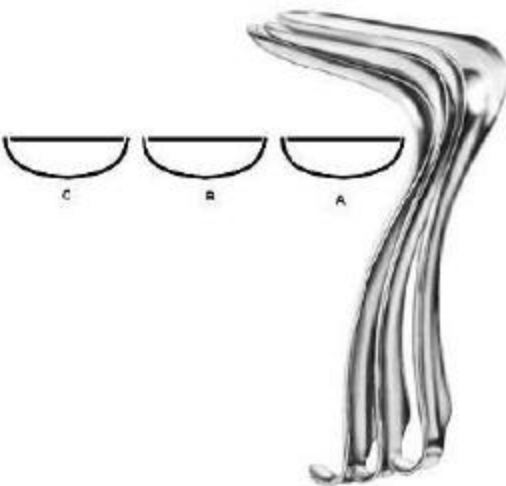

Kristeller
SST-20-116-01
Vaginal Speculum
105 x 26 mm

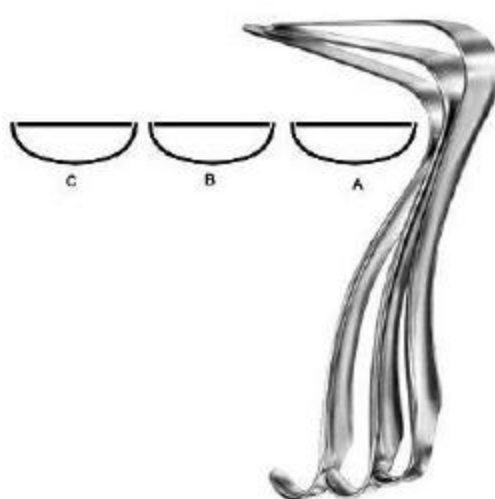

Kristeller
SST-20-117-01
Vaginal Retractor
115 x 22 mm, 115 x 23 mm



Kristeller
SST-20-118-01
Vaginal Speculum
Size 1

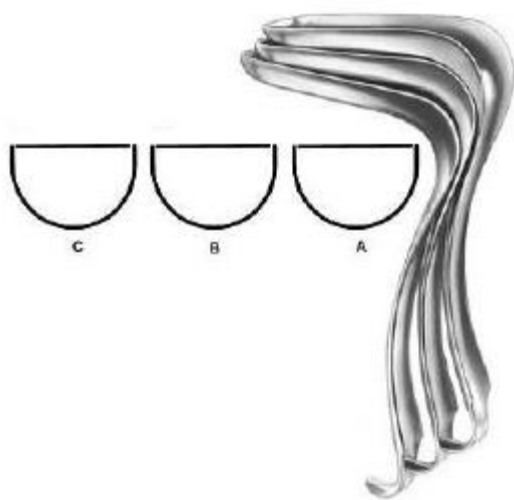

Kristeller
SST-20-119-01
Vaginal Speculum
110 x 27 mm

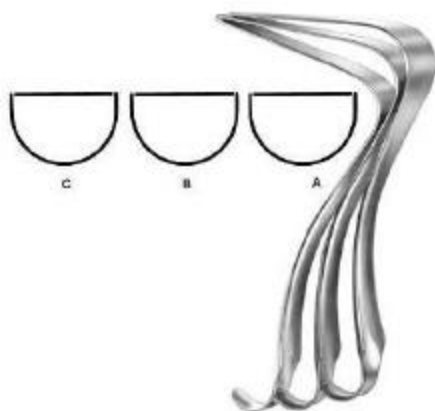

Kristeller
SST-20-120-01
Vaginal Retractor
115 x 23 mm

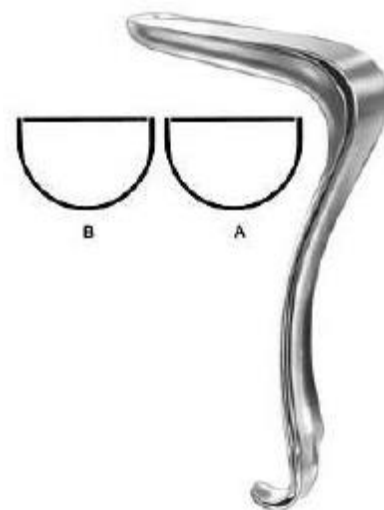

Kallmorgen
SST-20-121-01
Vaginal Speculum



Kallmorgen
SST-20-122-01
Vaginal Retractor
70 x 40 mm Fig. 1, 90 x 40 mm Fig. 2



Kallmorgen
SST-20-123-01
Vaginal Speculum
70 x 33 mm, 90 x 33 mm

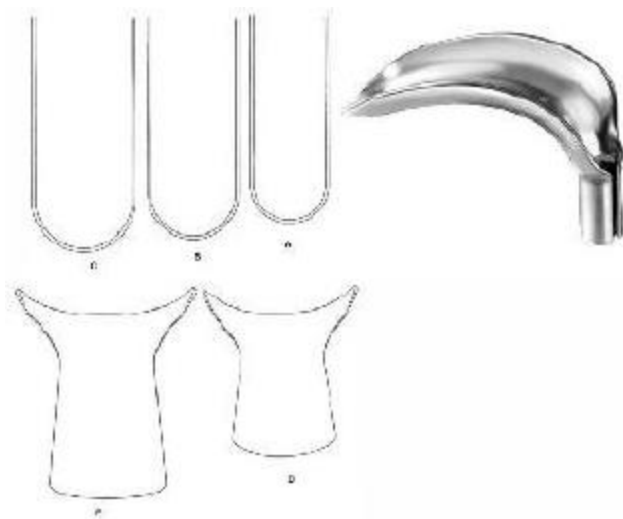

Scherbak
SST-20-125-00
Vaginal Speculum
Size 1



Auvard
SST-20-126-22
Vaginal Speculum
80 x 43 mm



Weissbarth
SST-20-127-24
Vaginal Speculum
21 cm 80 x 42 mm



Breisky
SST-20-128-20
Vaginal Speculum
29 cm 100 x 20 mm, 29 cm 100 x 25 mm



Kogan
SST-20-129-24
Endocervical Speculum
25 cm 70 x 30 mm



Kogan
SST-20-130-24
Endocervical Speculum
24.5 cm



Hegar
SST-20-131-24
Uterine Dilator
18.5 cm 1,0



Hegar
SST-20-132-02
Uterine Dilator
20 cm 1,0



Hank
SST-20-133-10
Uterine Dilator
26.5 cm Fig. 9/10



Sims
SST-20-134-32
Uterine Sound
33 cm



Valleix
SST-20-135-25
Uterine Sound
29.5 cm



Braun
SST-20-136-26
Uterine Depressor
27.5 cm



Schroder
SST-20-137-25
Uterine Tenaculum Forceps
25.5 cm



Braun
SST-20-138-25
Uterine Tenaculum Forceps
26 cm



Duplay
SST-20-139-28
Uterine Tenaculum Forceps
25.5 cm



Beacham
SST-20-140-26
Amniotome
26 cm



Skene
SST-20-141-24
Uterine Tenaculum Forceps
24 cm

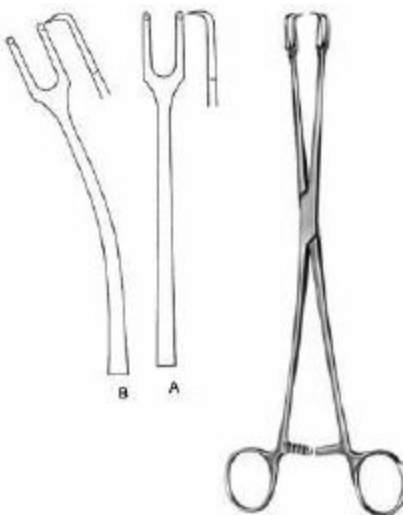

Schroder
SST-20-142-24
Uterine Tenaculum Forceps
25 cm

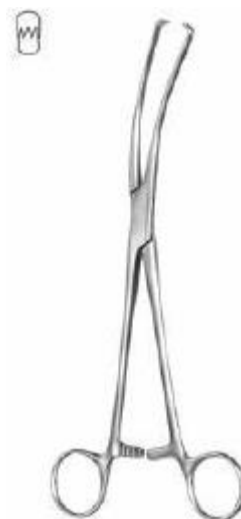

Teale
SST-20-143-23
Uterine Tenaculum Forceps
23.5 cm

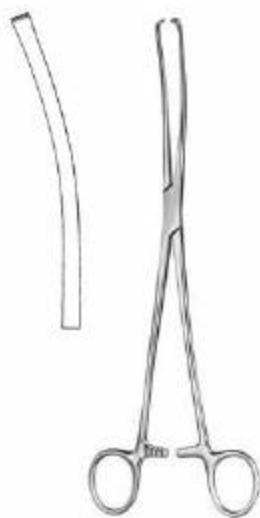

Iowa
SST-20-144-26
Uterine Tenaculum Forceps
26 cm



Museux
SST-20-145-24
Uterine Tenaculum Forceps
24 cm



JacoSST
SST-20-146-21
Uterine Tenaculum Forceps
21 cm

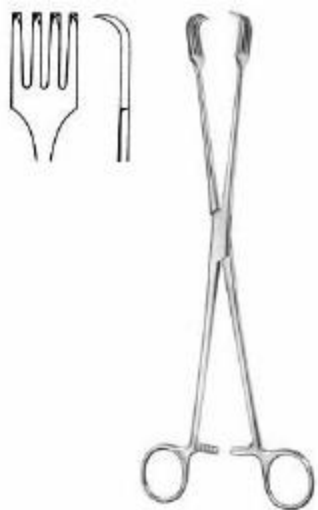

Uterine Tenaculum Forcep
SST-20-147-26
Uterine Tenaculum Forcep
26.5 cm



Braun
SST-20-148-16
Uterine Tenaculum Forceps
16 cm



Czerny
SST-20-149-21
Uterine Tenaculum Forceps
21 cm



Kelly
SST-20-150-32
Uterine Polypus Forceps
32 cm



Noto
SST-20-151-27
Uterine Polypus Forceps
27 cm

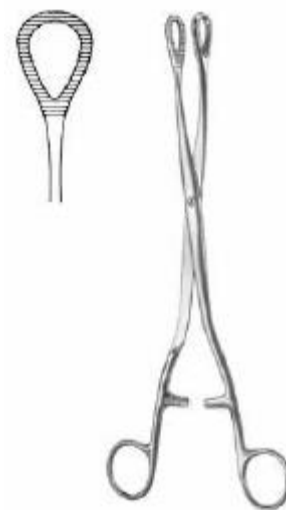

Heywood-Smith
SST-20-152-25
Uterine Polypus Forceps
25 cm



Doyen
SST-20-153-17
Myoma Screw
17 cm



Doyen
SST-20-154-17
Myoma Screw
14.5 cm



Segond
SST-20-155-27
Myoma Knife
28 cm



Dartigues

SST-20-156-27

Uterine Seizing Forceps

28 cm



Somer

SST-20-157-27

Uterine Seizing Forceps

22.5 cm



Collin

SST-20-158-25

Uterine Seizing Forceps jaw 40 mm wide

26 cm



Ayre

SST-20-159-23

Conization Knife cutting edge 3,6 mm wide

23.5 cm



Emmett

SST-20-160-03

Fistula Hook

22 cm Fig.3



Simon

SST-20-161-22

Fistula Hook

21.5 cm



Simon
SST-20-162-22
Fistula Hook
21.5 cm



Novak
SST-20-163-23
Suction Curette 4 mm ?
24.5 cm



Kevorkian
SST-20-164-23
Uterine Biopsy Curette 6,0 mm ?
30 cm



Munchen
SST-20-165-27
Uterine Biopsy Curette 4,8 mm ?
27 cm



Gellhorn
SST-20-166-23
Uterine Biopsy Forceps jaw 8,6 mm wide
24 cm



Faure
SST-20-167-21
Faure Uterine Biopsy Forceps
21 cm



Schubert

SST-20-168-21

Uterine Biopsy Forceps jaw 4,8 mm wide
21.5 cm, 28 cm



Thoms-Gaylor

SST-20-169-22

Uterine Biopsy Forceps jaw 5,6 mm ?
21 cm, 23.5 cm



Schubert

SST-20-170-26

Schubert Uterine Biopsy Forceps
25.5 cm



Van Doren

SST-20-171-24

Uterine Biopsy Forceps jaw 4,9 mm wide
27 cm, 25.5 cm



Alexander

SST-20-172-28

Uterine Biopsy Forceps jaw 5,1 mm wide
28 cm



Kevorkian

SST-20-173-32

Uterine Biopsy Forceps
25 cm

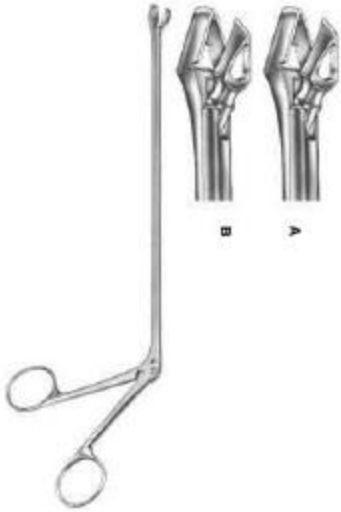

Schumacher
SST-20-174-01

Uterine Biopsy Forceps jaw 4,6 / 5,4 mm
wide
24 cm



Schumacher
SST-20-175-00

Uterine Biopsy Forceps
25 cm



IUP Grasping Forceps 3 Mm ?
SST-20-176-22

IUP Grasping Forceps 3 mm ?
22 cm

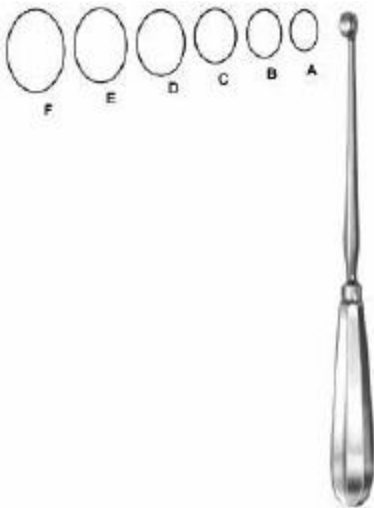

Simon
SST-20-177-01

Uterine Scoop
24.5 cm 9,8 x 8,6 mm, 24.5 cm 11,6 x 8,3 mm



Simon
SST-20-178-01

Uterine Scoop
30 cm 9,8 x 8,6 mm, 30 cm 11,6 x 8,3 mm



Recamier
SST-20-179-05

Uterine Curette
31 cm Fig. 00 5 mm, 31 cm Fig. 0 6 mm



Recamier

SST-20-180-05

Uterine Curette

31 cm Fig. 00 5 mm, 31 cm Fig. 0 6 mm



Sims

SST-20-181-05

Uterine Curette

31 cm Fig. 00 5 mm, 31 cm Fig. 0 6 mm



Sims

SST-20-182-05

Uterine Curette

31 cm Fig. 00 5 mm, 31 cm Fig. 0 6 mm



Suction Curette

SST-0-183-03

Suction Curette

29 cm 3,0 mm ?, 29 cm 4,5 mm ?, 29 cm 6,0 mm ?



Martin
SST-21-101-34
Pelvimeter cm, inch scale
34 cm



Nagele
SST-5-102-36
OSSTetrical Forceps
35 cm, 40.5 cm



Simpson
SST-5-103-30
OSSTetrical Forceps
31 cm



Wrigley
SST-5-104-28
OSSTetrical Forceps
28 cm



Simpson
SST-21-105-36
OSSTetrical Forceps
36.5 cm



Kielland
SST-21-106-41
OSSTetrical Forceps
42 cm

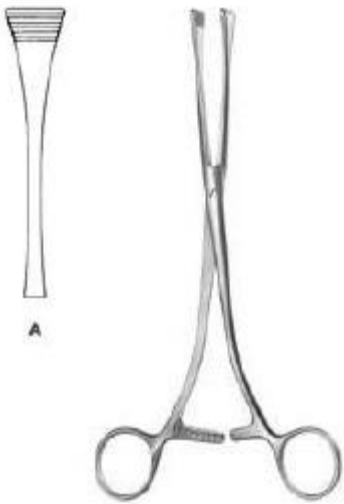

Green-Armytage
SST-21-107-21
Uterine Clamp
21 cm



Sellheim
SST-21-108-28
OSSTetrical Lever
32 cm

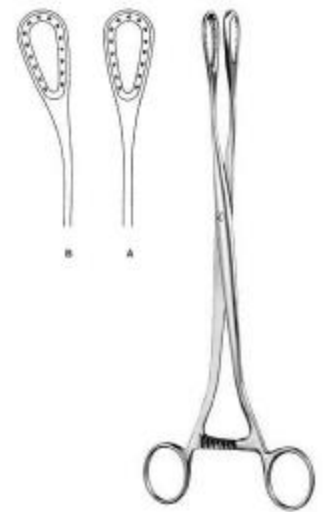

Sanger
SST-21-109-27
Placenta and Ovum Forceps
27.5 cm, 27 cm

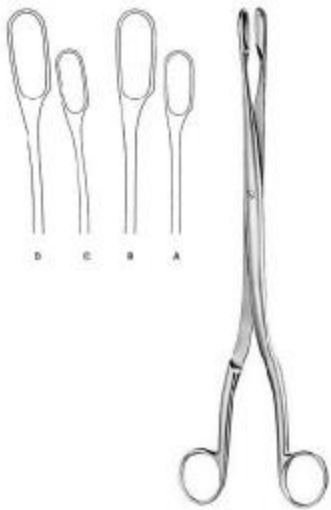

Winter
SST-21-110-01
Placenta and Ovum Forceps
28 cm Fig. 1, 28 cm Fig. 2

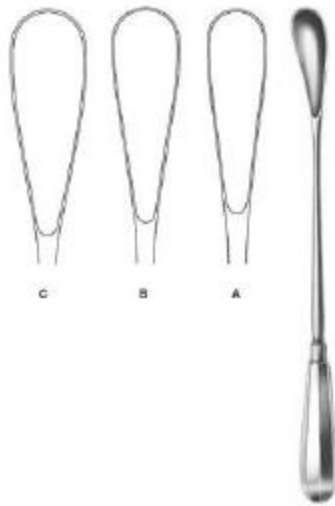

Cuzzi
SST-21-111-01
Placenta Scoop
30 cm 14,5 mm, 30 cm 18 mm



Pestalozza
SST-21-112-30
Placenta Scoop
30 cm

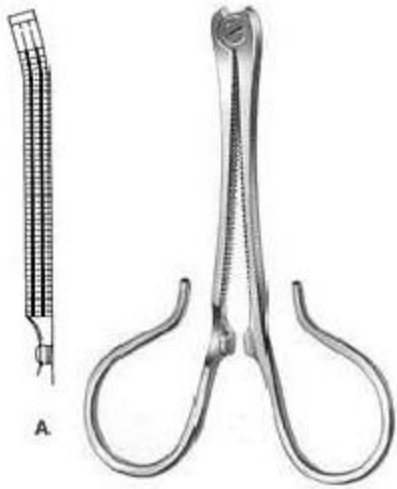

Kane
SST-21-113-08
Umbilical Cord Clamp
8.5 cm



Collin
SST-21-114-09
Umbilical Cord Clamp
8.5 cm

Sterilization



Irrigator
SST-23-101-10
Sterilization
Size 1



Round Bowl
SST-23-102-16
Sterilization
220 mm x 70 mm, 400 mm x 150 mm



Round Bowl
SST-23-103-33
Sterilization
? x h 6,00 l



Flat Dish
SST-23-104-11
Sterilization
? x h 0,20 l



Lid Only
SST-23-105-11
Sterilization
Size 1



Stainless Steel
SST-23-106-04
Sterilization
? x h 0,30 l

Sterilization



Round Dish

SST-23-107-11

Sterilization

? x h 0,30 l, ? 128 x 38 mm 0,40 l



Flat Dish

SST-23-108-11

Sterilization

? x h 0,15 l



Measurer

SST-23-109-01

Graduated inside

100cc = 0,1 l



Measurer

SST-23-110-02

Graduated Inside

0,25 l, 0,50 l



Petri Dish

SST-23-111-10

with Lid ? x h



Petri Dish

SST-23-112-09

without lid ? x h

Size 1

Sterilization



Lid For Petri Dishes
SST-23-113-10
Sterilization
Size 1



Universal Tray
SST-23-114-23
Sterilization
l x b x h



Instrument Tray
SST-23-115-21
Sterilization
l x b x h



Universal Tray
SST-23-116-23
Sterilization
l x b x h



Round Bowl
SST-23-117-22
Sterilization
? x h



Metal Jar
SST-23-118-30
Sterilization
? 30mm x 90 mm, ? 50mm x 100 mm

Sterilization



Instrument Box
SST-23-119-16
lid with knob
l x b x h



Instrument Box
SST-23-120-16
lid with knob
l x b x h



Instrument Box
SST-23-121-20
Sterilization
l x b x h



Round Metal Box
SST-23-122-06
Sterilization
? 75 mm x 75 mm, ? 100 mm x 60 mm



Medicine Cup Graduated Inside
SST-23-123-25
Sterilization
25 cm



Medicine Cup Graduated Inside
SST-23-124-50
Sterilization
50 cm

Sterilization



Tablet Tray
SST-23-125-75
Sterilization
? 75 mm x 12 mm



Metal Cup
SST-23-126-90
Sterilization
? 90 mm x 90 mm



Denture Cup
SST-23-127-75
Sterilization
? 75 mm x 50 mm



Insert For Cup
SST-23-128-75
Sterilization
? 73 mm x 75 mm



Kidney Dish
SST-23-129-17
Kidney Dish
l x b x h



Placenta Pan
SST-23-130-36
Sterilization
Size 1

Sterilization



Waste Cotton Collector
SST-23-131-01
Sterilization
? 50 mm x 75 mm



Spirit Lamp
SST-23-132-07
Sterilization
120 cm



Charrière
SST-7-102-35
Amputation Saw
35 cm



Langenbeck
SST-7-103-23
Amputation Saw
24.5 cm



Charrière
SST-7-104-27
Amputation Saw
26.5 cm



Reamer
SST-7-105-14
Reamer
13.5 cm



Perthes
SST-7-106-18
Reamer
18 cm



Perthes
SST-7-107-21
Reamer
21.5 cm



Reamer
SST-7-108-14
Reamer
14 cm



Flat Trephine
SST-7-111-18
Flat Trephine



Wire Twisting Forceps
SST-7-112-01
Wire Twisting Forceps
15.5 cm, 18 cm, 20 cm



Wire Twisting Forceps
SST-7-113-15
Wire Twisting Forceps
15.5 cm



Flat Nose Plier
SST-7-114-17
Flat Nose Plier
18.5 cm



Wire Twisting Forceps
SST-7-115-18
Wire Twisting Forceps
19 cm



Combi-Flat Nose Plier
SST-7-116-15
Combi-Flat Nose Plier
15 cm



Flat Nose Plier
SST-7-117-01
Flat Nose Plier
18 cm

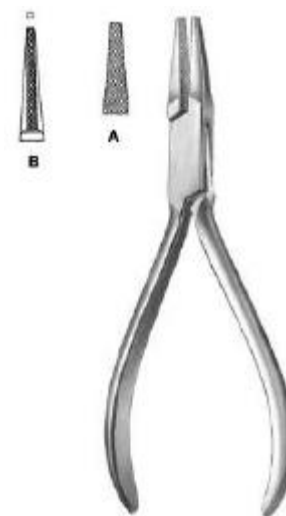

Flat Nose Plier
SST-7-118-14
Flat Nose Plier
13.5 cm



Hackstock
SST-7-119-16
Flat Nose Plier
16 cm



Flat Nose Plier
SST-7-120-01
Flat Nose Plier
17.5 cm



Wire Cutting Pliers
SST-7-121-18
Wire Cutting Pliers
18.5 cm



Wire Cutting Pliers
SST-7-122-15
Wire Cutting Pliers
15 cm



Wire Cutting Pliers
SST-7-123-18
Wire Cutting Pliers
17.5 cm



Demel
SST-7-124-18
Wire Guide
28 cm Fig. 3 , 29 cm Fig. 2 , 31 cm Fig. 1

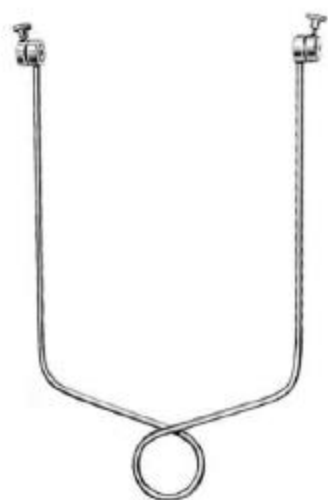

Bohler
SST-7-125-15
Extension Bow



Kirschner
SST-7-126-01
Extension Bow
18.5 cm , 26.5 cm



Traction Hook For Extension
Bows
SST-7-127-06
Traction Hook for Extension Bows



Kirschner
SST-7-128-06
Wire Drill
6 cm, 12 cm



Kirschner
SST-7-129-06
Wire Drill
14 cm, 16 cm



Kirschner
SST-7-130-10
Wire Drill
31 cm



Kirschner
SST-7-131-10
Wire Drill
12 cm, 16 cm, 18 cm



Kirschner
SST-7-132-10
Wire Drill
31 cm



Buckley
SST-7-133-02
Chisel
16 cm



Buckley
SST-7-134-02
Gouge
16 cm



Stout
SST-7-135-03
Bone Chisel
21 cm



Bone Chisel
SST-7-112-01
Bone Chisel
18 cm



Bone Chisel
SST-7-137-04
Bone Chisel
18 cm



Bone Chisel
SST-138-04
Bone Chisel
17 cm



Bone Chisel
SST-7-139-04
Bone Chisel
17 cm

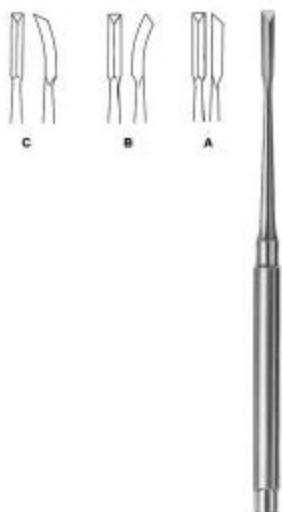

Gardner
SST-7-112-01

Bone Chisel

17 cm 4mm



Snyder-O.S.U.
SST-7-141-03

Bone Chisel

16.5 cm 3mm , 16.5 cm 5.5mm



O.S.U.
SST-7-142-01

one Chisel

17 cm 7mm



O.S.U.
SST-7-143-01

one Chisel

17 cm 9mm



Osteotome
SST-7-144-08

Osteotome

13.5 cm 8mm , 13.5 cm 10mm , 13.5 cm
12mm , 13.5 cm 14mm , 13.5 cm 16mm



Chisel
SST-7-145-08

Chisel

13.5 cm 8mm , 13.5 cm 10mm , 13.5 cm
12mm , 13.5 cm 14mm , 13.5 cm 16mm



Gouge
SST-7-146-08

Gouge
13.5 cm 8mm , 13.5 cm 10mm , 13.5 cm 12mm , 13.5 cm 14mm , 13.5 cm 16mm



Partsch
SST-7-147-02

Chisel
13.5 cm 2mm, 13.5 cm 3mm , 13.5 cm 4mm , 13.5 cm 5mm , 13.5 cm 6mm , 17 cm 2mm , 17 cm 3mm , 17 cm 4mm , 17 cm 5mm , 17 cm 6mm



Partsch
SST-7-148-02

Gouge
13.5 cm 2mm, 13.5 cm 3mm , 17 cm 2mm , 17 cm 3mm



Stille
SST--7-149-10

Chisel
20 cm 10mm , 20 cm 15mm , 20 cm 20mm , 20 cm 25mm



Stille
SST--7-150-10

Osteotome
20 cm 10mm , 20 cm 15mm , 20 cm 20mm , 20 cm 25mm



Stille
SST-7-151-10

Gouges
20 cm 10mm , 20 cm 15mm , 20 cm 20mm , 20 cm 25mm



Lambotte, Mini

SST-7-152-02

Osteotome

12.5 cm 2mm , 12.5 cm 3mm , 12.5 cm 4mm , 12.5 cm 6mm



Lambotte

SST-7-153-15

Osteotome

24 cm 15mm , 24 cm 20mm , 24 cm 25mm , 24 cm 30mm



Lambotte

SST-7-154-15

Osteotome

24 cm 15mm , 24 cm 20mm , 24 cm 25mm , 24 cm 30mm



Smith-Petersen

SST-7-155-06

Osteotome

20.5 cm 6mm , 20.5 cm 9mm , 20.5 cm 13mm



Smith-Petersen

SST-7-156-06

Osteotome

20.5 cm 6mm , 20.5 cm 9mm , 20.5 cm 13mm , 20.5 cm 16mm , 20.5 cm 19mm



Smith-Petersen

SST-7-157-09

Gouge

20.5 cm 9mm , 20.5 cm 14mm , 20.5 cm 19mm , 20.5 cm 25mm



Smith-Petersen

SST-7-158-09

Gouge

20.5 cm 9mm , 20.5 cm 14mm , 20.5 cm 19mm



Hoke

SST-7-159-03

Osteotome

17 cm 3mm , 17 cm 5mm , 17 cm 6mm , 17 cm 8mm



HibSST

SST-7-151-10

Osteotome

24.5 cm 6mm , 24.5 cm 13mm , 24.5 cm 19mm

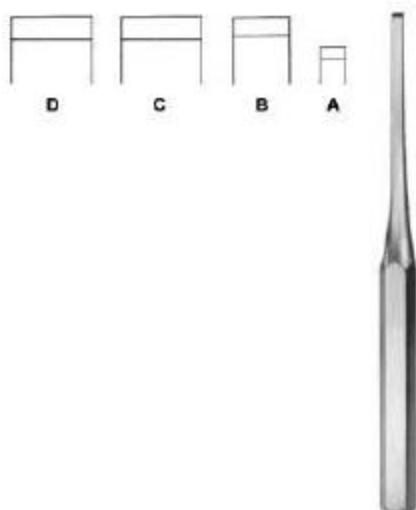

HibSST

SST-7-161-06

Chisel

24.5 cm 6mm , 24.5 cm 13mm , 24.5 cm 19mm

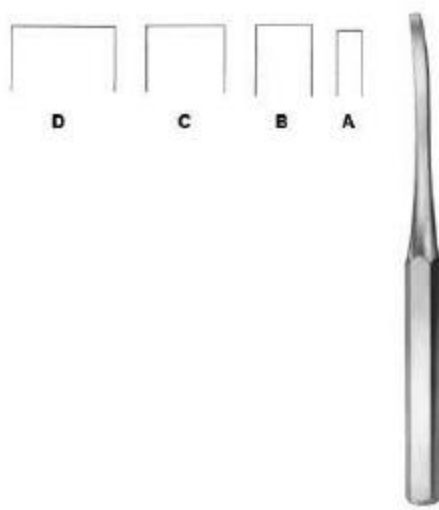

HibSST

SST-7-162-06

Osteotome

24.5 cm 6mm , 24.5 cm 13mm , 24.5 cm 19mm

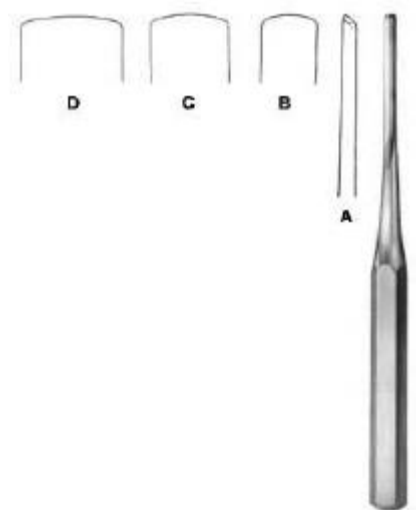

HibSST

SST-7-163-06

HibSST

24.5 cm 6mm , 24.5 cm 13mm , 24.5 cm 19mm

Bone Surgery



HibSST
SST-7-164-06

Gouge
24.5 cm 6mm , 24.5 cm 13mm , 24.5 cm
19mm

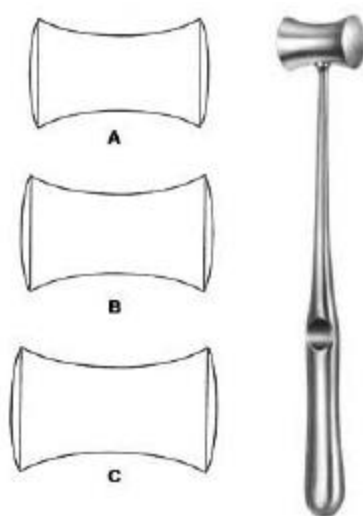

Williger
SST-7-165-01

Mallet
24 cm

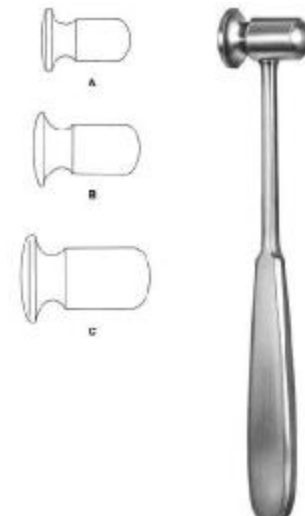

Doyen
SST-7-166-01

Mallet
20.5 cm, 21 cm, 21.5 cm



Collin
SST-7-151-10

Mallet
20 cm



Lucae
SST-7-168-01

Mallet
19.5 cm



Cottle
SST-7-169-19

Mallet
19 cm



Williger
SST-7-170-01
Mallet
16.5 cm



Mead
SST-7-171-17
Mallet
19 cm



Partsch
SST-7-172-18
Mallet
19 cm



Schede
SST-7-173-01
Bone Curette Fig. 0 to 4
17 cm



Kahre-Williger
SST-7-201-04
Periosteal Elevator
4 mm, 5 mm, 7 mm



Periosteal Elevator
SST-7-202-06
Periosteal Elevator
17 cm 6mm , 17 cm 8mm



Volkman
SST-7-174-01

Bone Curette

17 cm Fig. 0, 17 cm Fig. 00 , 17 cm Fig. 000 , 17 cm Fig. 1 , 17 cm Fig. 2 , 17.5 cm Fig. 3, 17.5 cm Fig. 4



Doyen

SST-7-203-17

Rib Raspatory

17.5 cm

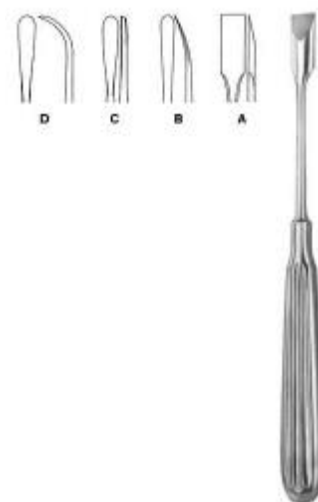

West

SST-7-204-19

Periosteal Elevator, double-ended

17 cm , 17.5 cm



Bruns

SST-7-175-01

Bone Curette

17 cm Fig. 0, 17 cm Fig. 00 , 17 cm Fig. 000 , 17 cm Fig. 1 , 17 cm Fig. 2 , 17 cm Fig. 3 , 17 cm Fig. 4

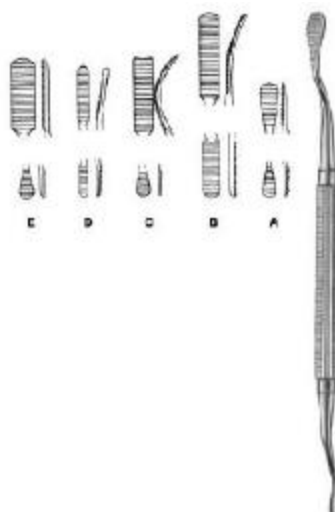

Miller-Colburn

SST-7-209-01

Bone File

18 cm Fig. 1, 18 cm Fig. 2, 18 cm Fig. 3, 18 cm Fig. 4, 18 cm Fig. 5



Spratt

SST-7-175-01

Bone Curette

17 cm Fig. 0, 17 cm Fig. 00 , 17 cm Fig. 000 , 17 cm Fig. 0000 , 17 cm Fig. 1 , 17 cm Fig. 2 , 17 cm Fig. 3 , 17 cm Fig. 4 , 17 cm Fig. 5



Miller-Colburn

SST-7-210-01

Bone File

18 cm Fig. 1, 18 cm Fig. 2, 18 cm Fig. 3, 18 cm Fig. 4



Langenbeck

SST-7-211-20

Elevator



Bruns

SST-7-177-01

Bone Curette

23 cm Fig. 0 , 23 cm Fig. 00 , 23 cm Fig. 000 , 23 cm Fig. 1 , 23 cm Fig. 2 , 23 cm Fig. 3



Martin-Langenbeck

SST-7-212-01

Elevator

17 cm 5mm , 17 cm 7mm , 17 cm 8mm



Scoville

SST-7-178-25

Bone Curette

25 cm



Vickers

SST-7-213-17

Elevator

17 cm



Vickers
SST-7-214-17
Dissector
17 cm

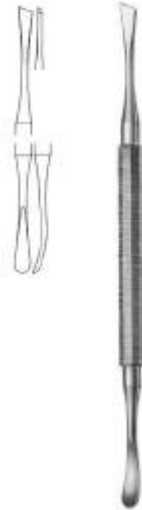

Simon
SST-7-179-01
Bone Curette



Williger
SST-7-215-17
Elevator
16.5 cm 5.5mm

25 cm Fig. 1 , 25 cm Fig. 2 , 25 cm Fig. 3 ,
25 cm Fig. 4 , 25 cm Fig. 5



Modell USA
SST-7-180-01

Bone Curette

16 cm Fig. 1, 16 cm Fig. 2, 16 cm Fig. 3, 16
cm Fig. 4



Williger
SST-7-216-16

Elevator
16.5 cm 5.5mm



Mead
SST-7-217-17

Mallet
19 cm



Periosteal Elevator
SST-7-218-18
Periosteal Elevator



Hohmann
SST-7-219-43
Bone Lever
23.5 cm



Modell USA
SST-7-181-01
Bone Curette

15.5 cm Fig. 1 , 15.5 cm Fig. 2 , 15.5 cm Fig. 3 , 15.5 cm Fig. 4



Lempert
SST-7-220-19
Bone Rongeur
19 cm



Modell USA
SST-7-182-01
Bone Curette

15.5 cm Fig. 1 , 15.5 cm Fig. 2 , 15.5 cm Fig. 3 , 15.5 cm Fig. 4



Luer
SST-7-221-17
Bone Rongeur
18 cm, 18.5 cm



Zaufal-Jansen
 SST-7-222-18
 Bone Rongeur
 18 cm



Halle
 SST-7-183-01
 Bone Curette
 21 cm Fig. 1 , 21 cm Fig. 2, 21 cm Fig. 3

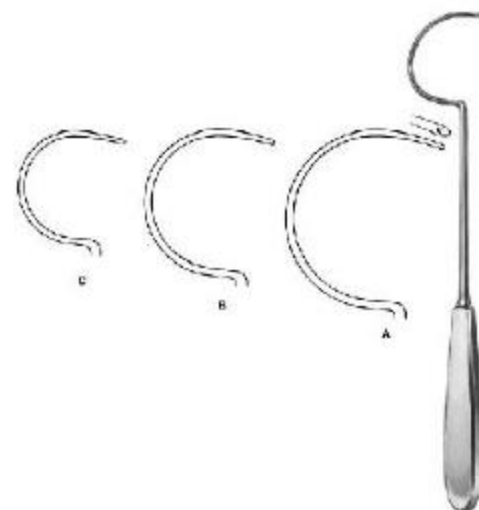

Demel
 SST-7-124-01
 Wire Guide
 31 cm Fig. 1



Volkman
 SST-7-184-01
 Bone Curette, double-ended
 12.5 cm, 14.5 cm , 17 cm



Volkman
 SST-7-185-13
 Bone Curette, double-ended
 13 cm , 16 cm



Bone Curette
 SST-7-186-21
 Bone Curette, double-ended
 21 cm



Williger
SST-7-187-00

Bone Curette, double-ended
13.5 cm Fig. 00/0 , 13.5 cm Fig. 0/1 , 13.5
cm Fig. 1/2



Hemingway
SST-7-189-11

Bone Curette, double-ended
18 cm



Hemingway
SST-7-190-00

Bone Curette, double-ended
18.5 cm



Bone Curette
SST-7-191-01

Bone Curette, double-ended
17.5 cm

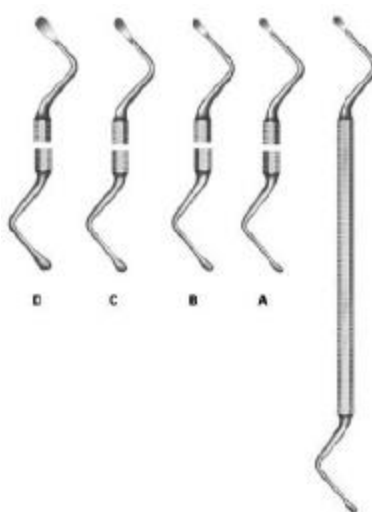

Lucas

SST-7-192-11

Bone Curette, double-ended
18 cm

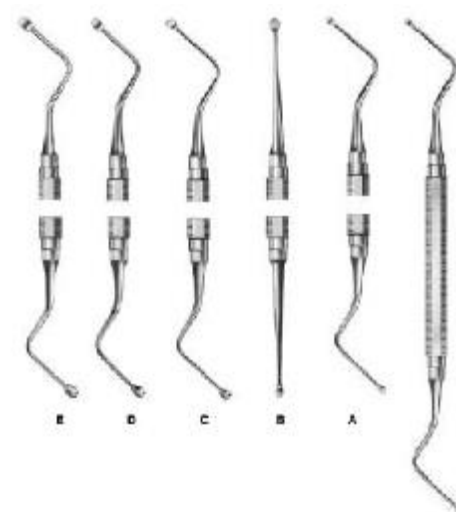

Miller-Colburn

SST-7-193-00

Bone Curette, double-ended
17 cm Fig. 0, 17 cm Fig. 1 , 17 cm Fig. 2 ,
17 cm Fig. 3



Molt
SST-7-194-01
Bone Curette

17 cm Fig. 1 , 17 cm Fig. 2 , 17 cm Fig. 3 ,
17 cm Fig. 4

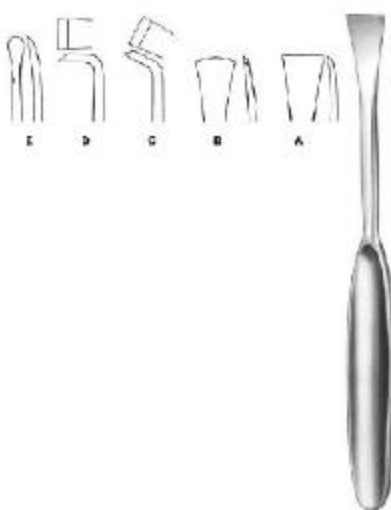

Martin-Langenbeck
SST-7-195-01
Periosteal Elevator

19 cm 16mm



Langenbeck
SST-7-196-18
Periosteal Elevator

18.5 cm



Langenbeck
SST-7-197-19
Periosteal Elevator

19.5 cm



Periosteal Elevator
SST-7-198-05
Periosteal Elevator

Periosteal Elevator



Sedillot
SST-7-199-21
Periosteal Elevator

22 cm 15mm



Williger
SST-7-200-13
Periosteal Elevator
12.5 cm 5mm



Kahre-Williger
SST-7-201-04
Periosteal Elevator
4 mm, 5 mm, 7 mm



Periosteal Elevato
SST-7-202-06
Periosteal Elevato
17 cm 6mm , 17 cm 8mm



Doyen
SST-7-203-17
Rib Raspatory
17.5 cm

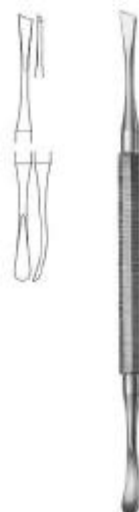

West
SST-7-204-19
Periosteal Elevator, double-ended
18.5 cm



SUPER STEEL
I N S T R U M E N T S



CONTACT US

Website : www.sstinst.com
E-Mail : info@sstinst.com
Phone : +92-340-4131531
Address : Kashmir Road, Sialkot, Pakistan

